



Instrumentation Industries, Inc.

Products for:

Anesthesia **Respiratory Care** **Emergency Medicine**

- Airway Management
- Emergency Ventilation
- O₂ Delivery
- Patient/Facility Accessories
- Pressure Monitoring
- Ventilator Circuits

Providing Quality Medical Products for over **50** years!

4 ways to order!

1. Online: iiimedical.com

- Orders can be securely placed **online 24 hours a day**.
- Please include a purchase order number (*if available*) when ordering.

2. Phone: **1-800-633-8577** (*inside USA*) — **1-412-854-1133** (*outside USA*)

- Our Customer Service Representatives are available to take your orders **Monday through Friday, 8:30 A.M. to 5:00 P.M. EST.**
- Please have a purchase order number available when ordering.
- Volume discounts may be available. Please inquire at the time you place your order.

3. Fax: **1-877-633-8661** (*inside USA*) — **1-412-854-5668** (*outside USA*)

- Previous customers can fax orders **24 hours a day**.
- Please include a purchase order number and customer number when ordering.

4. Dealers: iiimedical.com

- To find one of our worldwide dealers, visit iiimedical.com.
or call **1-800-633-8577** (*inside USA*) — **1-412-854-1133** (*outside USA*)

Ordering Information:

- We accept **American Express, Visa or MasterCard.**



Shipping / Terms:

- F.O.B. Bethel Park, PA, USA. Prepaid and added to invoice.

Satisfaction Guarantee:

- All **Instrumentation Industries, Inc.** products are manufactured to exacting specifications, in accordance with all relevant national and international regulations, and are carefully inspected before shipment.
- Our products are fully guaranteed against defects in material and workmanship.

Returns:

- Returns are accepted within **30 days** of purchase in the original packaging and are subject to a **20% restocking fee**. Please have your **Invoice Number** when calling to obtain an **Authorized Return Number**.

Technical Assistance:

- Our experienced staff can help with specific problems or questions regarding the use, function and application of our products.

1-800-633-8577 (*inside USA*) — **1-412-854-1133** (*outside USA*)



**Instrumentation
Industries, Inc.**
Since 1967

Our Story

We breathe easy when the world breathes easier...are watchwords for our small company. We saw the need for user-friendly products for medical/respiratory professionals and went to work to develop and produce practical solutions.

We manufactured just one product about 50 years ago which we advertised on a postcard. Our latest 36-page catalog features 250 products that contribute to the value, quality, comfort and safety of the healing process.

Our small and innovative production team continues to drive our mission to provide the very best respiratory/ anesthesia products for patient care. Our employees are dedicated. Most of them have worked with us for many years. Our motivation is knowing that our customers depend on us to produce reliable products.

Mission Statement

Instrumentation Industries, Inc. manufactures and distributes respiratory and anesthesia devices for the medical community. We provide practical solutions that complement respiratory and anesthesia applications. Our focus is to contribute to the value, quality, comfort, and safety of the healing process. This shared sense of purpose encompasses all aspects of our organization.

Quality Policy

Instrumentation Industries, Inc. strives to provide our customers with safe, reliable and effective medical devices that meet or exceed their expectations. This is to be accomplished in accordance with all relevant national and international regulations.

We are committed to maintaining the effectiveness of the Quality Management System and the establishment, periodic review, and achievement of our Quality Objectives.

*Instrumentation Industries, Inc. is certified to **ISO 13485:2016** and conforms to the requirements of **MDSAP** for the **USA** and **Canada**.*



Environmental Policy

Instrumentation Industries, Inc. is committed to the protection of the environment and the health and safety of its employees, customers and neighbors. At III, our goals are continuous improvement, finding ways to do more with less, to reduce & recycle our waste, and to become efficient in every way possible.

*This catalog is printed in the **USA** on **recycled paper** with **soy-based inks**.*

*Visit **iiimedical.com** or call **1-800-633-8577** (inside USA) **1-412-854-1133** (outside USA) for our **REACH**, **RoHS**, and **Conflict Mineral Statements**.*



Edward C. Horey, Jr.
Edward C. Horey, Jr.
President

Table of Contents

| Product | Page | Product | Page |
|---|-------------|--|-------------|
| Adapter — Inline Aerosol | 6 | Exhalation Valve with Water Trap | 14 |
| Adapters — Barbed Tubing | 32 | Filter — Bacterial/Viral | 21 |
| Adapters — Exhalation Valve | 14 | Flexible Support Arms | 16 |
| Adapters — Flowmeter/Air Compressor | 33 | Flexible Support Arms — Brackets and Accessories | 16-17 |
| Adapters — Gauge | 22 | Flowmeter/Air Compressor Adapters | 33 |
| Adapters — General | 7 | Flowmeter Security Devices | 33 |
| Adapters — MDI (Metered Dose Inhaler) | 4-5 | Gauge — Pressure | 20 |
| Adapters — Pressure | 9 | Gauge Adapters | 22 |
| Adapters — Reducing | 8 | Gauge Clamps — Pole and Rail | 22 |
| Adapters — Specialty | 6 | Gauge Covers | 22, 36 |
| Adapters — Swivel Barbed Tubing | 32 | Gauge Crystals | 20, 21, 36 |
| Adapters — Tee | 7 | Gauge Stand | 22 |
| Airways — Oropharyngeal | 24 | Gauges — Vacuum/Pressure | 20 |
| Anesthesia Flush Plug | 28 | Hose Assemblies — High Pressure | 29 |
| Anesthesia Holster | 28 | Knobs — Replacement | 16 |
| Auto-PEEP Measurement Device | 15 | Laryngoscope Blades and Handles | 25 |
| Bag Hangers | 30 | Laryngoscope Replacement Bulbs | 25 |
| Bags — Breathing | 29 | Manual Jet Ventilators & Replacement Parts | 23 |
| Bracket — Multi-Purpose Rail-Mounted Slide | 17 | Mask/Filter Storage Boxes & Replacement Seals | 34 |
| Brackets — Flexible Support Arms | 16 | Metered Dose Inhaler (MDI) Adapters | 4-5 |
| Breast Marker | 36 | Metered Dose Inhaler Adapter Cap | 4 |
| Breathing Bags | 29 | NIF (Negative Inspiratory Force) Meters | 21 |
| Bronchoscope Swivels & Caps | 12 | Non-Rebreathing Tee Valve | 12 |
| Cap — MDI Adapter | 4 | Nose Clip | 36 |
| Cap — Patient Wye Connector Temp. Probe Port | 11 | O₂ Enrichment Kit and Manifold | 19 |
| Caps — Bronchoscope Swivel | 12 | O₂ Flow Selector Valve | 31 |
| Caps — Pressure Adapter | 9 | O₂ Instant Flow Valves | 30-31 |
| "Christmas Tree" Connectors | 32 | O₂ Instant Flow Valves Bag Hangers | 30 |
| Clamps — Gauge | 22 | O₂ Instant Flow Valve Wall Mount | 31 |
| Connector — 5-in-1 | 33 | O₂ Tank Wrench | 33 |
| Connectors — 90° Elbow | 9 | One-Way Valves | 13 |
| Connectors — Hose | 10 | Oropharyngeal Airways | 24 |
| Connectors — Patient Wye | 11 | Oxygen/No Smoking Signs | 35 |
| Connectors — Silicone Rubber | 10 | PEEP Valves | 13 |
| Cuff Pressure Monitors & Adapter | 27 | Pilot Tube Repair Kit | 27 |
| Endotracheal Tube Changers | 26 | Safety Strap | 17 |
| Exhalation Valves | 14 | Screwdriver — Reversible | 35 |
| Exhalation Valves — Adapters and Replacement Parts | 14 | Silicone Rubber Connectors | 10 |

Table of Contents

| Product | Page | Product | Page |
|--|------|---------------------------------------|-------|
| Temp. Probe Port Cap — Patient Wye Connector | 11 | Vacuum/Pressure Gauges | 20 |
| Test Lungs | 15 | Ventilator Tubing — Accessories | 17 |
| Thermometer — LCD | 12 | Ventilator Tubing — Cuffed & Cuffless | 18-19 |
| Transtracheal Catheters | 24 | Water Traps | 15 |

To locate a specific product, turn to the **inside back cover** for our **Product Index**, where all Instrumentation Industries, Inc. products are listed by part number.

General Product Information

Most Instrumentation Industries, Inc. products are made in the USA.

Turn to the **inside back cover** for information on which products are USA-made.





All products are packaged as **Non-Sterile** (except ACU 1060.1 & ACU 1060.2).

Always follow the **Sterilization and High Level Disinfection Recommendations** included in the product's package insert, if applicable.

Visit iiimedical.com for:

- An up-to-date listing of **Sterilization and High Level Disinfection Recommendations**
- **Latex, DEHP, & BPA** information
- **Package Insert/User Instructions**, where applicable
- **Current price**

Product Symbols used in this catalog

| | |
|---|--|
|  | Reusable Products are intended for repeated use. Follow facility guidelines for reprocessing. |
|  | Single Patient Use Products are intended to be used on a single patient only. |
|  | Single Patient Reuse Products are intended to be used to repeatedly administer medications to one single patient while installed in a breathing circuit. |
|  | Products with this symbol need a prescription to purchase. Call our customer service for information. |
|  | Products with this symbol pose unacceptable risks to the patient, medical staff or other persons within the magnetic resonance imaging (MRI) environment. |

Catalog publication date: **April 2019**

MDI Adapters

MDI Adapters allow for delivery of aerosol medication from **Standard MDI Canisters**.

- ▶ Delivers medication through **Fiber-Optic Bronchoscopy Adapters** or directly via **Endotracheal Tube**
- ▶ Accepts canisters with **metal** or **plastic** tips

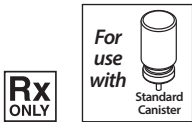

RTC 21-A MDI Adapter

- ▶ Polyetherimide
- ▶ Packaged: **5** or **10**



RTC 21-D MDI Adapter

- ▶ Polystyrene Butadiene
- ▶ Packaged: **50** or **100**



How they work

MDI Adapters

At Endotracheal Tube

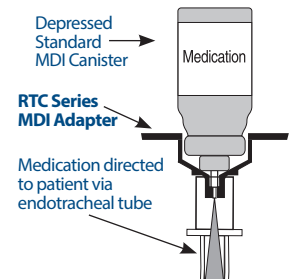

Inline MDI Adapters

Inline MDI Adapters direct aerosol medication mainstream from **Standard MDI Canisters** for ventilator patients.

- ▶ Tight-fitting **Cap** maintains proper patient ventilation between treatments
- ▶ **Arrows** clearly mark direction of airflow
- ▶ 6 inches of tubing can be added to create a chamber when applicable
- ▶ Accepts canisters with **plastic** or **metal** tips

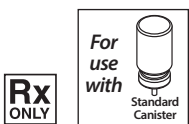

RTC 15-D Pediatric Inline MDI Adapter

- ▶ Thermoplastic Rubber Cap
- ▶ Polystyrene Butadiene
- ▶ Packaged: **50** or **100**



RTC 15-P Pediatric Inline MDI Adapter

- ▶ Thermoplastic Rubber Cap
- ▶ Polystyrene Butadiene
- ▶ Packaged: **50** or **100**



RTC 22-A Adult Inline MDI Adapter

- ▶ Silicone Rubber Cap
- ▶ Polyetherimide
- ▶ Packaged: **5** or **10**



RTC 22-D Adult Inline MDI Adapter

- ▶ Thermoplastic Rubber Cap
- ▶ Polystyrene Butadiene
- ▶ Packaged: **50** or **100**



RTC 23-A Adult Inline MDI Adapter

- ▶ Silicone Rubber Cap
- ▶ Polyetherimide
- ▶ Packaged: **5** or **10**



RTC 23-D Adult Inline MDI Adapter

- ▶ Thermoplastic Rubber Cap
- ▶ Polystyrene Butadiene
- ▶ Packaged: **50** or **100**

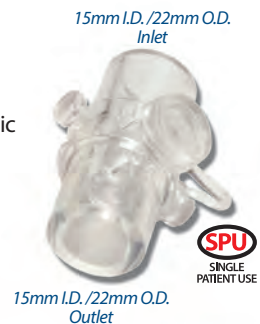

How they work

RTC Series Inline MDI Adapters

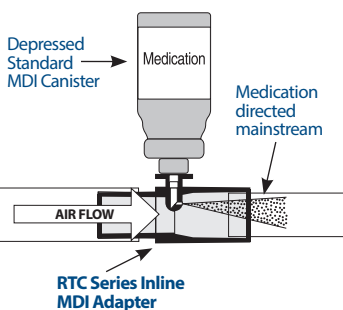

RTC 17-1 Inline MDI Adapter Replacement Cap

- ▶ For **RTC 22-A** & **RTC 23-A**
- ▶ Silicone Rubber
- ▶ Packaged: **5** or **50**



Universal Inline MDI Adapters

Universal Inline MDI Adapters direct aerosol medication mainstream for ventilator patients.

▶ 2 types: for **22mm I.D. Ventilator Circuits** & for **15mm I.D. Ventilator Circuits**

▶ **Single Patient Reuse**

(Can be used to repeatedly administer medications to one single patient while installed in a breathing circuit.)

▶ Accepts **MDI Canisters with a dose counter**

▶ Advances certain **dose counters**

▶ Accepts **Standard MDI Canisters** with **metal** or **plastic** tips

▶ **Arrows** clearly mark direction of airflow

▶ Tight-fitting **Thermoplastic Rubber Cap** maintains proper patient ventilation between treatments

▶ Polystyrene Butadiene

▶ Packaged: **25** or **50**

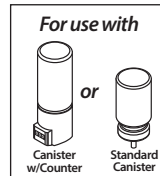

RTC 24-V
Adult Universal
Inline MDI Adapter



RTC 24-VP
15mm Universal
Inline MDI Adapter

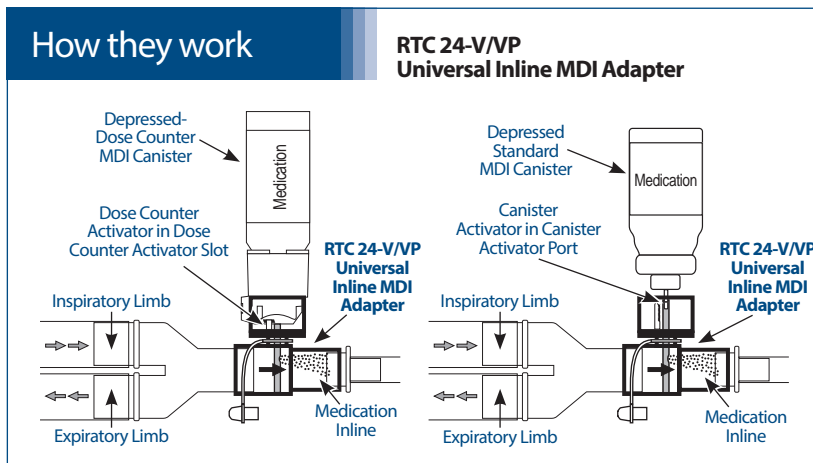

Adult Universal Inline MDI Adapter Kit

Adult Universal Inline MDI Adapter Kit creates a reservoir for our **RTC 24-V Adult Universal Inline MDI Adapter**.

RTC 24-V KIT

Adult Universal Inline MDI Adapter Kit

▶ **Single Patient Reuse**

(Can be used to repeatedly administer medications to one single patient while installed in a breathing circuit.)

▶ Can be used at the endotracheal tube or the inspiratory limb of **22mm I.D.** circuits.

▶ Packaged: **10**

▶ **Includes:**

- A** **RTC 24-V**
Adult Universal Inline MDI Adapter
— Polystyrene Butadiene
w/Thermoplastic Rubber Cap
- B** **KC 2124** — Adapter
— Polystyrene Butadiene
- C** **KC 004-5** — Tubing
— Polyolefin Plastomer

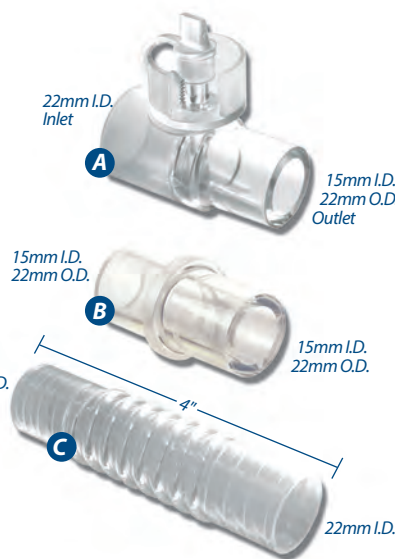
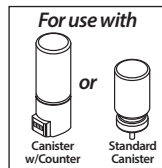

How they work

RTC 24-V KIT
Adult Universal Inline MDI
Adapter Kit

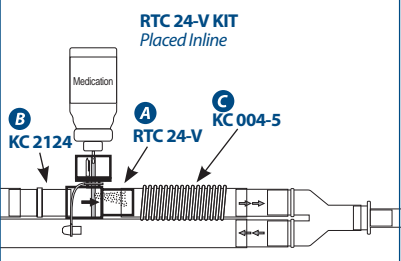
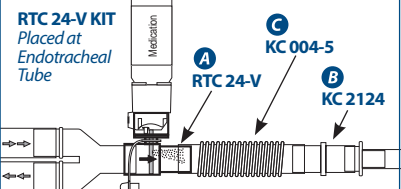

Inline Aerosol Adapter

Inline Aerosol Adapter allows a **Combivent® Respimat® Inhaler** to be adapted to a ventilator circuit. Immediately before the ventilator cycle, activate the **Combivent® Respimat® Inhaler**. The medication then becomes suspended in the Inline Aerosol Adapter until the inspiratory cycle of the ventilator carries it to the patient.

RTC 26-C Inline Aerosol Adapter

- ▶ **Single Patient Reuse**
(Intended to be used to deliver Combivent® (ipratropium bromide and albuterol) Respimat® medication multiple times to a single patient while installed in a breathing circuit.)
- ▶ Designed to fit in the Inspiratory Limb of the patient circuit
- ▶ Combivent® Respimat® Inhaler may be placed on **RTC 26-C Inline Aerosol Adapter** in either orientation
- ▶ **Clear Body** allows viewing of suspended medication after activation
- ▶ **Arrows** clearly mark direction of airflow
- ▶ Tight-fitting **Thermoplastic Rubber Cap** maintains proper patient ventilation between treatments
- ▶ Polystyrene Butadiene
- ▶ Patent Pending
- ▶ Packaged: **25** or **50**



Combivent® is a registered trademark of Boehringer Ingelheim Pharmaceuticals, Inc. Copyright© 2016 Boehringer Ingelheim International GmbH.
Respimat® is a registered trademark and used under license from Boehringer Ingelheim International GmbH.

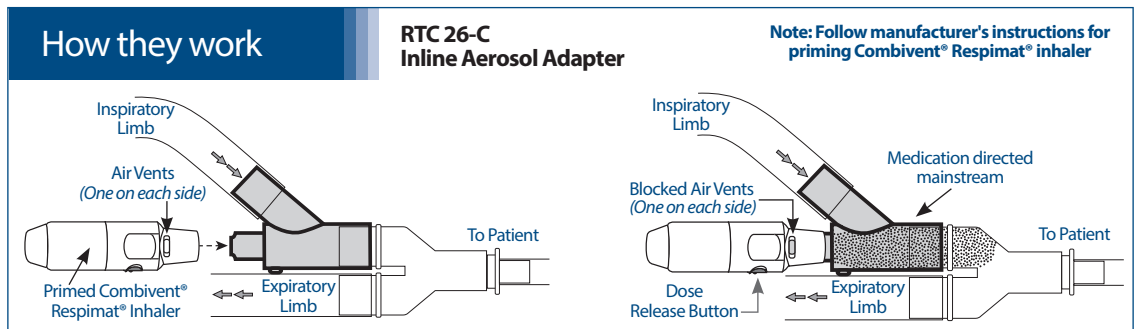
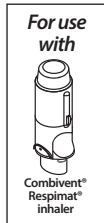

Specialty Adapters

Specialty Adapters increase treatment delivery options in special circumstances.

BE 106 Adult Adapter w/Vent

- ▶ Polycarbonate
- ▶ Packaged: **Individually**



BE 120-AKW 45° Adapter

- ▶ Polystyrene Butadiene
- ▶ Packaged: **100**



BE 120-22D Mouthpiece Adapter

- ▶ Polystyrene Butadiene
- ▶ Packaged: **100**



BE 105-2222 Adult Swivel Adapter

- ▶ For CPAP/BiPAP systems
- ▶ Polypropylene
- ▶ Packaged: **10** or **100**



Adapters
VS
Connectors

Adapters generally connect different sizes together.

Connectors generally connect items of the same size.



Order by Fax ▶ 1-877-633-8661

General Adapters

General Adapters are the same size on both ends for circuit customization when needed.

Adult

KC 105 Adult General Adapter

- ▶ Polycarbonate
- ▶ Packaged: 1 or 10



KC 2124 Adult General Adapter

- ▶ Polystyrene Butadiene
- ▶ Packaged: 25 or 100



BE 105-2X22 Adult General Adapter

- ▶ Polycarbonate
- ▶ Packaged: 5 or 25



BE 105-2X22D Adult General Adapter

- ▶ Polystyrene Butadiene
- ▶ Packaged: 20 or 100



Neonatal & Pediatric

KC 1010 Neonatal General Adapter

- ▶ Polystyrene Butadiene
- ▶ Packaged: 25 or 100



SG 1010 Neonatal General Adapter

- ▶ Polysulfone
- ▶ Packaged: 1 or 10



KC 1515 Pediatric General Adapter

- ▶ Polystyrene Butadiene
- ▶ Packaged: 25 or 100



We also have other Adapters not specifically for ventilator circuits!

Gauge Adapters [page 22](#)

Flowmeter/Air Compressor Adapters [page 33](#)

Tee Adapters

Tee Adapters help add versatility to patient circuits. Available in seven types to allow for various configurations during patient circuit assembly.

BE 117-W Tee Adapter

- ▶ High Density Polyethylene
- ▶ Packaged: 10

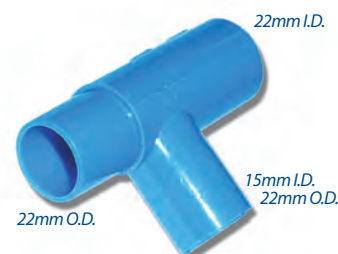

BE 125 Tee Adapter

- ▶ Polycarbonate
- ▶ Packaged: 1 or 10

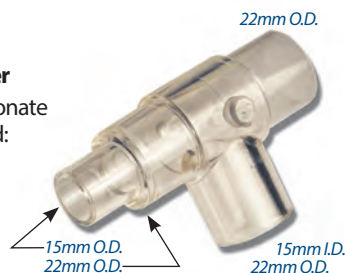

BE 125-1 Tee Adapter

- ▶ Polycarbonate
- ▶ Packaged: Individually



BE 125-1T Tee Adapter

- ▶ Polycarbonate
- ▶ Packaged: 1 or 10



BE 125-1TD Tee Adapter

- ▶ High Density Polyethylene
- ▶ Packaged: 10, 20 or 100



BE 16-2 Tee Adapter

- ▶ Polycarbonate
- ▶ Packaged: Individually



SG 218 Tee Adapter

- ▶ Polysulfone
- ▶ Packaged: 1 or 10



Reducing Adapters

Reducing Adapters are available in various configurations.

BE 190 Reducing Adapter

- ▶ Polycarbonate
- ▶ Packaged: 1 or 10



REUSABLE



BE 191 Reducing Adapter

- ▶ Polycarbonate
- ▶ Packaged: 1 or 10



REUSABLE



BE 192 Reducing Adapter

- ▶ Polycarbonate
- ▶ Packaged: 1 or 10



REUSABLE



BE 193 Reducing Adapter

- ▶ Polycarbonate
- ▶ Packaged: 1 or 10



REUSABLE



BE 139-105 Reducing Adapter

- ▶ Polycarbonate
- ▶ Packaged: 1 or 10



REUSABLE



BE 195-1522A Reducing Adapter

- ▶ Polyetherimide
- ▶ Packaged: 1 or 10



REUSABLE



KC 2119 Reducing Adapter

- ▶ Polystyrene Butadiene
- ▶ Packaged: 25



SINGLE PATIENT USE



KC 2126 Reducing Adapter

- ▶ Polystyrene Butadiene
- ▶ Packaged: 25 or 100



SINGLE PATIENT USE



NB 105-6 Reducing Adapter

- ▶ Polycarbonate
- ▶ Packaged: Individually



REUSABLE



SG 193-M Reducing Adapter

- ▶ Polysulfone
- ▶ Packaged: 1 or 10



REUSABLE



Adult to Pediatric or Neonatal

SG 101 Adult to Pediatric Reducing Adapter

- ▶ Polysulfone
- ▶ Packaged: 1 or 10



REUSABLE



SG 101-D Adult to Pediatric Reducing Adapter

- ▶ Polystyrene Butadiene
- ▶ Packaged: 25 or 100



SINGLE PATIENT USE



SG 102 Adult to Neonatal Reducing Adapter

- ▶ Polysulfone
- ▶ Packaged: 1 or 10



REUSABLE



Exceptional
Product
Quality

Our product quality is rigorously monitored throughout the entire manufacturing process.

Pressure Adapters

Pressure Adapters provide easy access for pressure measuring.

- ▶ For use in **Ventilator, BIPAP, or CPAP** circuits
- ▶ Can be placed in any **Adult, Pediatric, or Neonatal** circuit

Attach one of our **Vacuum/Pressure Gauges** for easy inline pressure measuring!

Page 20

BE 105-40 Pressure Adapter

- ▶ Capped Barbed Port Fits 3/16" I.D. tubing
- ▶ Silicone Rubber Port Cap
- ▶ Polycarbonate
- ▶ Packaged: **Individually**



BE 105-101-40 Pressure Adapter

- ▶ Capped Barbed Port Fits 3/16" I.D. tubing
- ▶ Silicone Rubber Port Cap
- ▶ Polycarbonate
- ▶ Packaged: **Individually**



BE 139 Pressure Adapter

- ▶ Barbed Port Fits 3/16" I.D. tubing
- ▶ Polycarbonate
- ▶ Packaged: **1 or 10**



KC 5 Pressure Adapter

- ▶ Luer Lock Port
- ▶ Polycarbonate
- ▶ Packaged: **Individually**



KC 6PA Pressure Adapter

- ▶ Capped Luer Lock Port
- ▶ Polystyrene Butadiene
- ▶ Packaged: **25 or 100**



MS 101-40 Pressure Adapter

- ▶ Barbed Port Fits 3/16" I.D. tubing
- ▶ Polycarbonate
- ▶ Packaged: **Individually**



NP 130-22 Pressure Adapter

- ▶ Capped Barbed Port Fits 1/4" I.D. tubing
- ▶ Silicone Rubber Port Cap
- ▶ Polycarbonate
- ▶ Packaged: **Individually**



Replacement Caps

- ▶ Silicone Rubber



BE 40A Replacement Cap

- ▶ Fits 1/4" - 9/32" barbs
- ▶ Replacement for: **NP 130-22**
- ▶ Packaged: **5 or 50**



BE 40H Replacement Cap

- ▶ Fits 3/16" - 7/32" barbs
- ▶ Replacement for: **BE 105-101-40 & BE 105-40**
- ▶ Packaged: **5 or 50**



90° Elbow Connectors

90° Elbow Connectors are available with a luer lock port or a barbed port to allow for gas sampling or pressure monitoring.

KC 18901-K 90° Elbow Connector

- ▶ Polystyrene Butadiene
- ▶ Packaged: **50**



KC 18901-L 90° Elbow Connector

- ▶ Capped Luer Lock Port
- ▶ Polycarbonate
- ▶ Packaged: **10 or 20**



KC 18901-O 90° Elbow Connector

- ▶ Barbed Port Fits 3/16" I.D. tubing
- ▶ Polycarbonate
- ▶ Packaged: **10 or 20**



KC 18901-P 90° Elbow Connector

- ▶ Polycarbonate
- ▶ Packaged: **10 or 20**



Visit iiimedical.com for an up-to-date listing of **Sterilization and High Level Disinfection Recommendations.**

Silicone Rubber Connectors

Silicone Rubber Connectors help to join circuit fittings when they don't quite fit. Dissimilar sizes, or accessories of the same size, can be used together. Make use of "odd" size accessories.

- ▶ Available in **Adult, Pediatric, & Neonatal**
- ▶ Remain pliable after sterilization
- ▶ Autoclavable
- ▶ Silicone Rubber
- ▶ Packaged: **10 or 50**

| | | | |
|---|---|---|--|
| <p>PF 001 Reducing Silicone Rubber Connector</p> <ul style="list-style-type: none"> ▶ Adult to Pediatric  <p>22mm I.D. 15mm I.D.</p> <p>R REUSABLE</p> | <p>PF 1510 Reducing Silicone Rubber Connector</p> <ul style="list-style-type: none"> ▶ Pediatric to Neonatal  <p>15mm I.D. 10mm I.D.</p> <p>R REUSABLE</p> | <p>PF 1515 Straight Silicone Rubber Connector</p> <ul style="list-style-type: none"> ▶ Pediatric  <p>15mm I.D. 15mm I.D.</p> <p>R REUSABLE</p> | <p>PF 1010 Straight Silicone Rubber Connector</p> <ul style="list-style-type: none"> ▶ Neonatal  <p>10mm I.D. 10mm I.D.</p> <p>R REUSABLE</p> |
| <p>BE 101-00-1426 Tapered Silicone Rubber Connector</p> <ul style="list-style-type: none"> ▶ Adult ▶ Large end also fits flanged 22mm O.D.  <p>27mm I.D. 22mm I.D.</p> <p>R REUSABLE</p> | <p>BE 101-00-3443 Straight Silicone Rubber Connector</p> <ul style="list-style-type: none"> ▶ Adult  <p>22mm I.D. 22mm I.D.</p> <p>R REUSABLE</p> | | |

Hose Connectors

Hose Connectors change a 15mm, 22mm or 30mm I.D. low pressure gas outlet source to a 1/4" I.D. small bore tubing connection. Also available, a 15mm O.D. x 1/2" hose barb connector (ADP 150) that fits 10mm I.D. tubing.

1/4" Tapered Barbed Connection

| | |
|--|---|
| <p>BE 145-2P Hose Connector</p> <ul style="list-style-type: none"> ▶ Polycarbonate ▶ Packaged: 10 or 50  <p>15mm O.D.</p> <p>R REUSABLE</p> | <p>BE 145-1522P Hose Connector</p> <ul style="list-style-type: none"> ▶ Polycarbonate ▶ Packaged: 10 or 50  <p>15mm I.D. 22mm O.D.</p> <p>R REUSABLE</p> |
| <p>KC 145-1522D Hose Connector</p> <ul style="list-style-type: none"> ▶ Polystyrene Butadiene ▶ Packaged: 25 or 100  <p>15mm I.D. 22mm O.D.</p> <p>SPU SINGLE PATIENT USE</p> | <p>BE 145-2230P Hose Connector</p> <ul style="list-style-type: none"> ▶ Polycarbonate ▶ Packaged: 10 or 50  <p>22mm I.D. 30mm O.D.</p> <p>R REUSABLE</p> |

1/2" Hose Barb Connection



15mm O.D.
1/2" O.D.

ADP 150
Hose Connector

- ▶ Fits cuffed **10mm I.D.** Tubing
- ▶ Polycarbonate
- ▶ Packaged: **10 or 50**

R
REUSABLE

Ventilator Tubing

In various lengths of adult, pediatric, & neonatal sizes



pages 18-19



Patient Wye Connectors

Reusable Patient Wye Connectors are available with pressure ports and/or temperature probe ports for easy monitoring of the circuit at the patient wye.

BE 127 Patient Wye Connector

- ▶ No monitoring ports
- ▶ Polycarbonate
- ▶ Packaged: 1 or 10



BE 127-40 Patient Wye Connector

- ▶ Pressure Port Fits 1/4" I.D. tubing
- ▶ Polycarbonate
- ▶ Packaged: 1 or 10



BE 127-7.5 Patient Wye Connector

- ▶ 7.5mm I.D. Temperature Probe Port
- ▶ Polycarbonate
- ▶ Packaged: 1 or 10

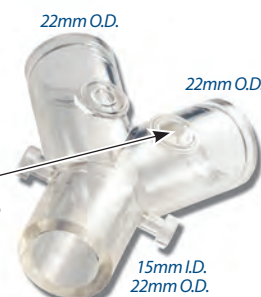

BE 127-7.5-40 Patient Wye Connector

- ▶ 7.5mm I.D. Temperature Probe Port
- ▶ Pressure Port Fits 1/4" I.D. tubing
- ▶ Polycarbonate
- ▶ Packaged: 1 or 10

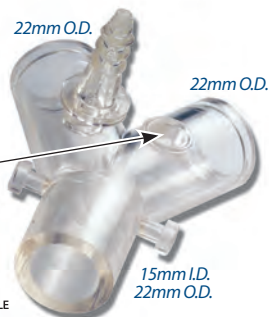

Temperature Probe Port Cap

CAP-S Temperature Probe Port Cap



- ▶ Fits: BE 127-7.5 & BE 127-7.5-40
- ▶ Thermoplastic Rubber
- ▶ Packaged: 5 or 50



Single Patient Use Patient Wye Connectors are available with ports at the patient wye.

KC 211-D 60° Patient Wye Connector

- ▶ 60° Wye
- ▶ 18mm I.D. 22mm O.D. Port
- ▶ Polystyrene Butadiene
- ▶ Packaged: 50 or 100

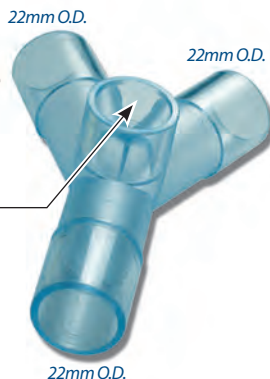

KC 212-D 90° Patient Wye Connector

- ▶ 90° Wye
- ▶ 18mm I.D. 22mm O.D. Port
- ▶ Polystyrene Butadiene
- ▶ Packaged: 50 or 100

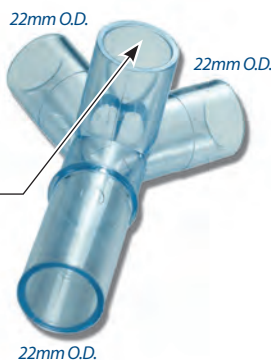

KC 213-D 60° Patient Wye Connector

- ▶ 60° Wye
- ▶ No Ports
- ▶ Polystyrene Butadiene
- ▶ Packaged: 50 or 100

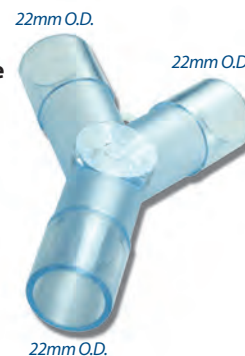

Patient circuits need

3

things...

1. Tubing
2. Support
3. Accessories

We provide all three!

Bronchoscope Swivels

Bronchoscope Swivels allow access to the patient's airway, while maintaining ventilation.

- ▶ Two **Interchangeable Silicone Rubber Caps**
 - One cap allows access for a **Fiber-Optic Bronchoscope**
 - One cap allows access for a **Suction Catheter**
- ▶ Replacement Caps available
- ▶ Polyetherimide
- ▶ Packaged: **1 or 10**



BE 105-7
Bronchoscope Swivel



BE 105-8
Bronchoscope Swivel

Replacement Caps

- ▶ Silicone Rubber



BE 105-7-1
Fiber-Optic Cap

- ▶ Packaged: **5**



RTC 17-1
Suctioning Cap

- ▶ Packaged: **5 or 50**



Bronchoscope Double Swivel

Bronchoscope Double Swivel has a **single cap** for both **fiber-optic** and **suction** access to a patient's airway.

SH 7-45
Bronchoscope Double Swivel

- ▶ Both Ends Swivel
- ▶ Polycarbonate
- ▶ Packaged: **25 or 50**



LCD Thermometer

LCD Thermometer helps monitor the temperature of ventilator or heated aerosol circuits.

Note: LCD readings are approximate and not a substitute for definitive temperature monitoring.

KM 030
LCD Thermometer

- ▶ LCD displays **28°, 31°, 34°, 37°, & 40°** Celsius markings.
- ▶ High Density Polyethylene
- ▶ Packaged: **50**



Non-Rebreathing Tee Valve

Non-Rebreathing Tee Valve isolates airflow and **decreases** the possibility of **nosocomial infection**. It can also reduce **respirometer** replacement costs. Low cracking pressure minimizes resistance to flow!

BE 117
Non-Rebreathing Tee Valve

- ▶ Polycarbonate
- ▶ Silicone Rubber Leaf Valves
- ▶ Packaged: **1 or 10**

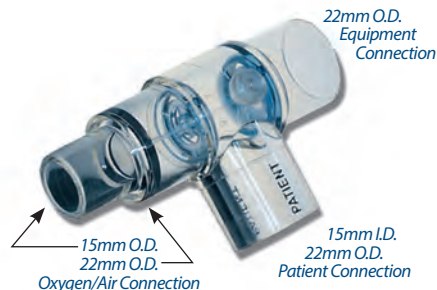

How it works

BE 117 — Non-Rebreathing Tee Valve

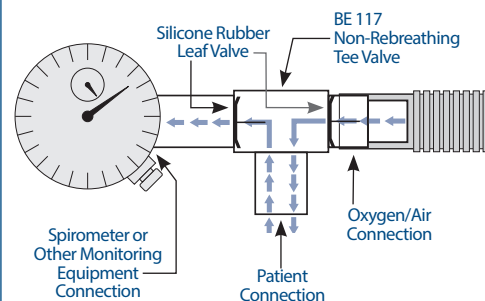

Magnetic PEEP Valves

Magnetic PEEP Valves are used with **ventilators, resuscitators**, or any system where **PEEP** or **CPAP** is required.

Caution: These are uni-directional PEEP Valves. Flow direction must be consistent with the expiratory flow. PEEP pressure may vary according to position. PEEP pressure must be monitored during use.

- ▶ Adjustable from **3 to 20 cm H₂O** pressure
- ▶ Clearly marked flow direction arrows
- ▶ Transparent
- ▶ Polycarbonate, Polypropylene, Silicone Rubber, & Stainless Steel
- ▶ Packaged: **Individually**



BE 142
Magnetic PEEP Valve
w/Silicone Rubber Connector



BE 30-142
Magnetic PEEP Valve

Replacement Outlet Ports

- ▶ Polycarbonate
- ▶ Packaged: **Individually**

BE 142-3 Replacement Outlet Port

- ▶ For: **BE 142**
- ▶ **22mm O.D. Outlet**



BE 30-142-3 Replacement Outlet Port

- ▶ For: **BE 30-142**
- ▶ **30mm O.D. Outlet**



One-Way Valves

One-Way Valves are available in different configurations to allow various placement options in a patient circuit. Clearly marked **flow-direction arrows** help ensure proper placement in the circuit.

- ▶ Low Resistance
- ▶ **Arrows** clearly mark direction of airflow
- ▶ Silicone Rubber Leaf Valve
- ▶ Packaged: **1 or 10**



BE 130 One-Way Valve

- ▶ Safety Lugs
- ▶ Polycarbonate



BE 131 One-Way Valve

- ▶ Safety Lugs
- ▶ Silicone Rubber Connector
- ▶ Polycarbonate



BE 130-22B One-Way Valve

- ▶ Polysulfone



BE 130-23BB One-Way Valve

- ▶ Polysulfone



Exhalation Valves

Exhalation Valves are available with various patient/inlet configurations. Replacement parts are available.

- ▶ Available in **Regular** or **Low Resistance**
- ▶ **Arrows** clearly mark direction of airflow
- ▶ Polyetherimide
- ▶ Packaged: **Individually**

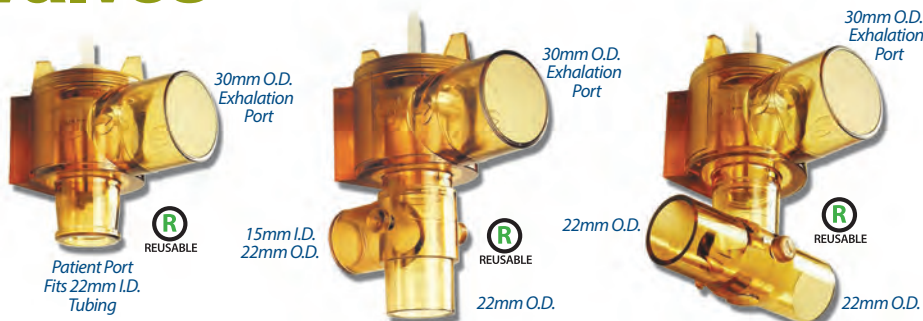

BE 30-115-B
Exhalation Valve
BE 30-115-BL
Low Resistance
Exhalation Valve

- ▶ Patient Port

NS 30-115-U
Exhalation Valve
NS 30-115-UL
Low Resistance
Exhalation Valve

- ▶ Patient Port
- ▶ Inlet Port

NS 30-115-5
Exhalation Valve
NS 30-115-5L
Low Resistance
Exhalation Valve

- ▶ Patient/Inlet
Port Tee

Rx
ONLY

Replacement Parts

BE 215-2A Diaphragm Assembly

- ▶ Fits: **All of our Exhalation Valves**
- ▶ Silicone Rubber Diaphragm
- ▶ Polypropylene Stem & Ring
- ▶ Packaged: **1 or 10**



REUSABLE

BE 115-2N Diaphragm Nut

- ▶ Fits: **All of our Exhalation Valves**
- ▶ Nylon
- ▶ Packaged: **5 or 25**



REUSABLE

BE 115-3B Diaphragm Holder

- ▶ Fits: **BE 30-115-B, NS 30-115-U, NS 30-115-5, PS 54A**
- ▶ Polyetherimide
- ▶ Packaged: **Individually**



REUSABLE

BE 115-3L Low Resistance Diaphragm Holder

- ▶ Fits: **BE 30-115-BL, NS 30-115-UL, NS 30-115-5L, PS 54AL**
- ▶ Polyetherimide
- ▶ Packaged: **Individually**



REUSABLE

Exhalation Valve Adapters

- ▶ Polyetherimide
- ▶ Packaged: **1 or 10**

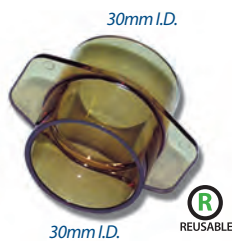

PS 54-1A
Exhalation
Valve Adapter



BE 195-A
Exhalation
Valve Adapter

Exhalation Valve with Water Trap

Exhalation Valve with Water Trap can help reduce disconnects and leaks by collecting excess moisture. Replacement Parts and Bottles are available.

PS 54A Exhalation Valve w/Water Trap

PS 54AL Low Resistance Exhalation Valve w/Water Trap

- ▶ Available in **Regular** or **Low Resistance**
- ▶ Capacity: **8 oz.** (250 ml)
- ▶ Includes **BE 195-A & PS 54-1A** Adapters
- ▶ Polyetherimide
- ▶ Polypropylene Bottle
- ▶ See **WT 250-BOT** for replacement bottle pg. 15
- ▶ Packaged: **Individually**



REUSABLE

Rx
ONLY



Water Traps

Water Traps allow excess moisture from humidity to be collected. A spring-loaded plunger maintains circuit integrity while bottle is emptied.

- ▶ Available in 2 capacities: **4 oz.** (125 ml) & **8 oz.** (250 ml)
- ▶ Internal Spring : Steel
- ▶ Connector : Polyetherimide
- ▶ Bottle & Bottle Insert: Polypropylene
- ▶ Packaged: **Individually**

WT 125 Water Trap

▶ 4 oz. (125 ml)



WT 250 Water Trap

▶ 8 oz. (250 ml)



Replacement Parts

- ▶ Polypropylene
- ▶ Packaged: **Individually**

WT 125-BOT

4 oz. (125 ml) Replacement Bottle

▶ For: **WT 125**

WT 250-BOT

8 oz. (250 ml) Replacement Bottle

▶ For: **WT 250**

▶ For: **PS 54A & PS 54AL Exhalation Valve w/ Water Trap** (pg. 14)



WT 125-BI

4 oz. (125 ml)

Replacement Bottle Insert

▶ For: **WT 125**

WT 250-BI

8 oz. (250 ml)

Replacement Bottle Insert

▶ For: **WT 250**



Auto-PEEP Measurement Device

Auto-PEEP Measurement Device allows **single-breath** measurement of **auto-PEEP**. Use on ventilators **not** equipped with **expiratory hold**.

KC 9-P

Auto-PEEP Measurement Device

- ▶ Removable Cap
- ▶ Can be used as a Braschi valve
- ▶ Polycarbonate
- ▶ Silicone Rubber Leaf Valve
- ▶ Packaged: **1 or 10**



How it works

KC 9-P Auto-PEEP Measurement Device

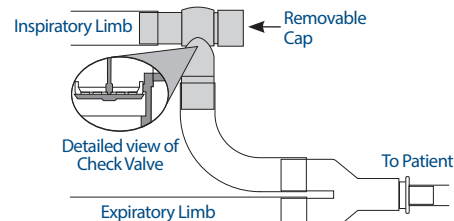

Test Lungs

Test Lungs are perfect for testing **ventilators, resuscitators, etc.** **Not made with natural rubber latex.**

- ▶ Available in 2 capacities: **750 ml** and **1-liter**.
- ▶ Not for patient use
- ▶ Cannot be cleaned with alcohol
- ▶ Green Neoprene
- ▶ Packaged: **1 or 5**



BE 150-5G
Test Lung
▶ 1-liter capacity



BE 150-5LF
Test Lung
▶ 750-ml capacity

Flexible Support Arms

Flexible Support Arms fit most ventilators or can be adapted to others by using one of our **Pole** or **Rail Mounts**.

- ▶ Available in 2 sizes, **24"** & **30"**
- ▶ Rotates **360°**
- ▶ Sleeve Base locks in place
- ▶ Vinyl-coated segmented arm
- ▶ Enhances patient comfort & safety
- ▶ Can be adapted to most ventilators by using our **Flexible Support Arm Brackets**
- ▶ Anodized Aluminum & Steel
- ▶ Packaged: **Individually**



BE 122-24

Flexible Support Arm

- ▶ **24"** & Extension for **38"** total length

BE 122-30

Flexible Support Arm

- ▶ **30"** & Extension for **44"** total length

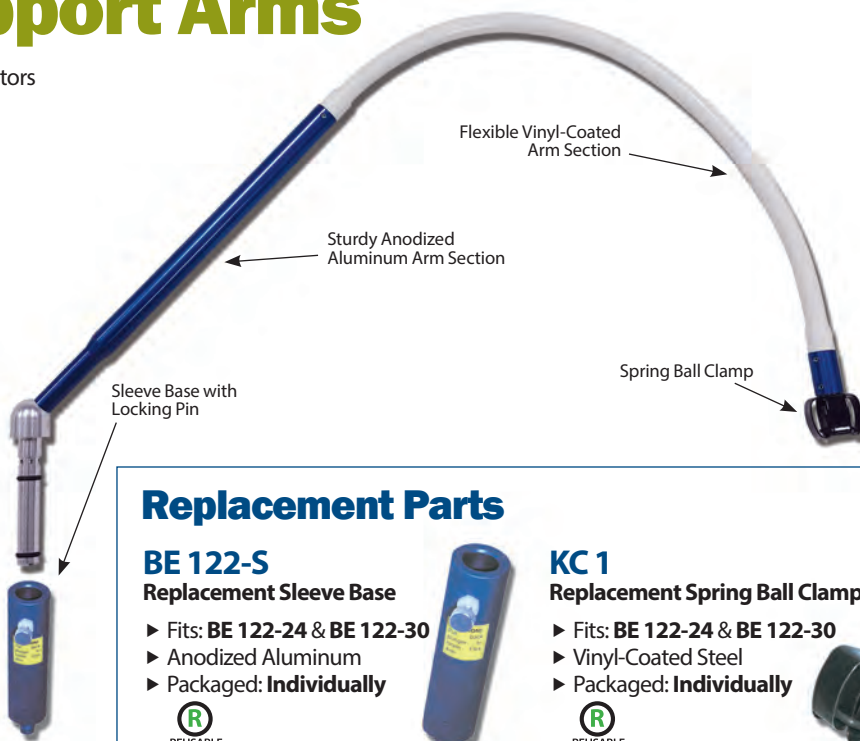

Replacement Parts

BE 122-S Replacement Sleeve Base

- ▶ Fits: **BE 122-24** & **BE 122-30**
- ▶ Anodized Aluminum
- ▶ Packaged: **Individually**



KC 1 Replacement Spring Ball Clamp

- ▶ Fits: **BE 122-24** & **BE 122-30**
- ▶ Vinyl-Coated Steel
- ▶ Packaged: **Individually**



Flexible Support Arm Brackets

Flexible Support Arm Brackets add even more versatility by allowing the mounting of **Flexible Support Arms** to most **ventilators, poles, beds, stretchers, etc.**

- ▶ Anodized Aluminum & Steel
- ▶ Packaged: **Individually**

3-Hole Pole-Mounted Brackets

BE 114-1

3-Hole Pole-Mounted Bracket

- ▶ Permits pole mounting of **Flexible Support Arms** on poles as large as **1"**



BE 114-2

3-Hole Pole-Mounted Bracket

- ▶ Permits pole mounting of **Flexible Support Arms** on poles as large as **1½"**



BE 114-5

Universal Rail-Mounted Bracket

- ▶ Permits rail mounting of **Flexible Support Arms**
- ▶ Does not fit on rails mounted flush to wall



RB 002

Compact Rail-Mounted Bracket

- ▶ Permits rail mounting of **Flexible Support Arms**
- ▶ For use with Fairfield-style rails only



Replacement Knobs

- ▶ Steel
- ▶ Packaged: **Individually**

BE 114-K

3-Hole Pole-Mounted Bracket Replacement Knob

- ▶ Fits: **BE 114-1** & **BE 114-2**
- ▶ Also fits: **BE 3000-PA** (pg. 30) & **BE 3000-PS** (pg. 30)



BE 114-5K

Universal Rail-Mounted Bracket Replacement Knob

- ▶ Fits: **BE 114-5**
- ▶ Also fits: **BE 148-5-1** (pg. 22), **BE 148-5-2** (pg. 22), **BE 3000-RA** (pg. 31) & **BE 3000-RS** (pg. 31)



RB KNOB

Rail-Mounted Bracket Replacement Knob

- ▶ Fits: **RB 002**
- ▶ Also fits: **RB 001** (pg. 17) & **RB 004** (pg. 22)



Flexible Support Arm Tubing Clamps

Flexible Support Arm Tubing Clamps hold large bore tubing in place. Specially designed for our **Flexible Support Arms**.

- ▶ Two types are available:
 - **Single Clamp** in 1 size
 - **Double Clamp** in 2 sizes, 4" or 8"
- ▶ Phenolic Ball Knob
- ▶ Polypropylene
- ▶ Anodized Aluminum (Double Tubing Clamps only)
- ▶ Steel
- ▶ Packaged: **Individually**

Single Tubing Clamp



BE 114-5TB
Single Tubing Clamp

Double Tubing Clamps



BE 122-2TSB
4" Double Tubing Clamp

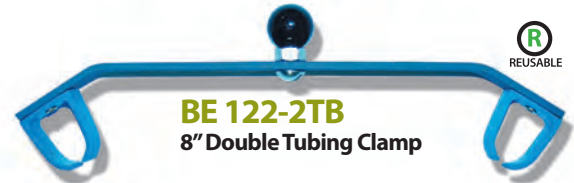

BE 122-2TB
8" Double Tubing Clamp

Ventilator Tubing Clamps

Swivel Tubing Clamp

Swivel Tubing Clamp attaches **large bore tubing** to **bedrails**.

BE 102

Swivel Tubing Clamp

- ▶ Fits tubing and rails 1/2" to 1" in diameter
- ▶ Swivels 360°
- ▶ Polypropylene
- ▶ Packaged: **20, 50, or 100**



Tubing Separator

Tubing Separator keeps **small bore tubing** fastened to, but separate from, **large bore tubing**.

KC 10

Tubing Separator

- ▶ Silicone Rubber
- ▶ Packaged: **10 or 100**



Safety Strap

Safety Strap allows any **adapter, connector, or valve** with **safety lugs** to be safely attached to a **ventilator circuit**.

Secures ventilator circuit attachment to a patient's airway. Helps prevent accidental disconnects.

Not made with natural rubber latex.

NP 105-1

Safety Strap

- ▶ 5 7/8" long
- ▶ 3/16" diameter center hole
- ▶ Neoprene
- ▶ Packaged: **10 or 50**

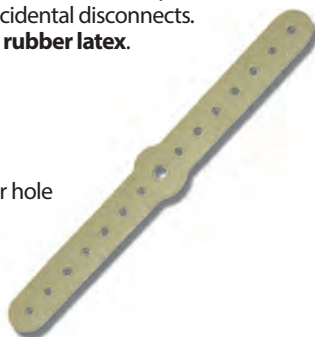

Multi-Purpose Rail-Mounted Slide Bracket

Multi-Purpose Rail-Mounted Slide Bracket allows for a variety of mounting options.

RB 001

Multi-Purpose Rail-Mounted Slide Bracket

- ▶ For use on Fairfield-style rails only
- ▶ Use on equipment requiring 1 1/8" x 3/16" mounting slot
- ▶ Can be mounted on a ventilator to secure heater for humidifying circuits
- ▶ Anodized Aluminum & Steel
- ▶ See pg. 16 for Replacement Knob
- ▶ Packaged: **Individually**



Ventilator Tubing

Ventilator Tubing is **transparent, non-conductive** and has a **corrugated spiral design** to prevent kinking. It has a **smooth internal diameter** which promotes laminar gas flow, and resists the trapping of water. Our ventilator tubing has industry standard connection diameters of **10, 15, or 22mm I.D.**

- ▶ **No minimum on Stock Lengths!**
- ▶ Packaged: **Individually**

Cuffed Ventilator Tubing



KC Series
Adult Ventilator Tubing

- ▶ 22mm I.D.
- ▶ Polyester Elastomer
- ▶ Silicone Rubber Cuffs

Stock Lengths

| | |
|--------------|--------------|
| KC 006 - 6" | KC 040 - 40" |
| KC 012 - 12" | KC 042 - 42" |
| KC 018 - 18" | KC 048 - 48" |
| KC 024 - 24" | KC 060 - 60" |
| KC 030 - 30" | KC 072 - 72" |
| KC 036 - 36" | |



KC-P Series
Pediatric Ventilator Tubing

- ▶ 15mm I.D.
- ▶ Polyester Elastomer
- ▶ Silicone Rubber Cuffs

Stock Lengths

| | |
|----------------|----------------|
| KC 006-P - 6" | KC 040-P - 40" |
| KC 012-P - 12" | KC 042-P - 42" |
| KC 018-P - 18" | KC 048-P - 48" |
| KC 024-P - 24" | KC 060-P - 60" |
| KC 030-P - 30" | KC 072-P - 72" |
| KC 036-P - 36" | |



KC-N Series
Neonatal Ventilator Tubing

- ▶ 10mm I.D.
- ▶ Polyester Elastomer
- ▶ Silicone Rubber Cuffs

Stock Lengths

| | |
|----------------|----------------|
| KC 006-N - 6" | KC 040-N - 40" |
| KC 012-N - 12" | KC 048-N - 48" |
| KC 018-N - 18" | KC 060-N - 60" |
| KC 024-N - 24" | KC 072-N - 72" |
| KC 030-N - 30" | |
| KC 036-N - 36" | |

Custom lengths of any style of **Ventilator Tubing** are available. *Minimum order requirements apply.*
 Call **1-800-633-8577** for info.

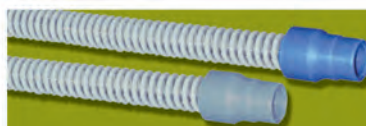

Minimum order requirements. Call **1-800-633-8577** for info.

Also available:
Adult Size 22mm I.D. Cuffed Ventilator Tubing
Gray Tubing with Blue Cuffs
 or **Gray Tubing with Gray Cuffs**

Cuffless Ventilator Tubing

KC-3 Series
Adult Ventilator Tubing

- ▶ 22mm I.D.
- ▶ Polyester Elastomer

Stock Lengths

| | |
|----------------|----------------|
| KC 006-3 - 6" | KC 036-3 - 36" |
| KC 012-3 - 12" | KC 042-3 - 42" |
| KC 018-3 - 18" | KC 060-3 - 60" |
| KC 024-3 - 24" | KC 072-3 - 72" |
| KC 030-3 - 30" | |



Order by Fax ▶ **1-877-633-8661**

Clear Cuffless Ventilator Tubing

Clear Cuffless Ventilator Tubing is **transparent, non-conductive** and has a **corrugated spiral design** to prevent kinking. It has a **smooth internal diameter** which promotes laminar gas flow, and resists the trapping of water. Our ventilator tubing has industry standard connection diameters of **10, 15, or 22mm I.D.**

- ▶ No minimum on Stock Lengths!
- ▶ Packaged: **Individually**

Clear Cuffless Ventilator Tubing



KC-5 Series
Adult Ventilator Tubing
 ▶ 22mm I.D.
 ▶ Polyolefin Plastomer

Stock Lengths

KC 004-5 - 4" KC 030-5 - 30"
 KC 006-5 - 6" KC 042-5 - 42"
 KC 018-5 - 18" KC 060-5 - 60"
 KC 024-5 - 24" KC 072-5 - 72"



KC-5P Series
Pediatric Ventilator Tubing
 ▶ 15mm I.D.
 ▶ Polyolefin Plastomer

Stock Lengths

KC 006-5P - 6"
 KC 012-5P - 12"
 KC 018-5P - 18"
 KC 024-5P - 24"
 KC 048-5P - 48"
 KC 060-5P - 60"



KC-5N Series
Neonatal Ventilator Tubing
 ▶ 10mm I.D.
 ▶ Polyolefin Plastomer

Stock Lengths

KC 004-5N - 4"
 KC 006-5N - 6"
 KC 012-5N - 12"
 KC 024-5N - 24"

O₂ Enrichment Kit

O₂ Enrichment Kit provides variable oxygen concentrations (up to **100%**) at the proximal airway. Can be used on home ventilators. Replacement manifolds are available.

SG 066
O₂ Enrichment Kit

- ▶ **Reusable** — Manifold, Tubing, & Bracket
- ▶ **Single Patient Use** — 1-liter Reservoir Bag
- ▶ Bracket fits on Standard Rails
- ▶ Neoprene Reservoir Bag
- ▶ Polysulfone Manifold
- ▶ Anodized Aluminum & Steel Bracket
- ▶ Packaged: **Individually**

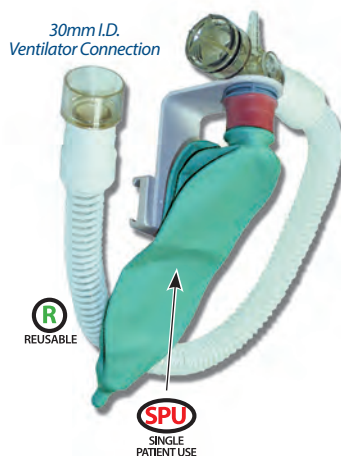

Replacement Parts

SG 066-2N
1-liter Breathing Bag

- ▶ Replacement for **SG 066**
- ▶ Not made with natural rubber latex.
- ▶ Neoprene
- ▶ Packaged: **1 or 25**



SG 066-1
Replacement Manifold

- ▶ Replacement for **SG 066**
- ▶ Polysulfone
- ▶ Packaged: **Individually**



Vacuum/Pressure Gauges

Vacuum/Pressure Gauges provide accurate vacuum or pressure monitoring.

- ▶ Accurate
- ▶ Sturdy
- ▶ Reliable
- ▶ Incremental graduations as low as **1cm H₂O**
- ▶ Easily **re-zeroed** for accuracy
- ▶ Internal Components: Aluminum, Brass, Copper Alloy & Steel
- ▶ Case: Acrylonitrile Butadiene Styrene (ABS)
- ▶ Crystal: Acrylic
- ▶ Packaged: **Individually**



**NS-S Series Gauge info for California customers:*



WARNING: These products can expose you to chemicals including Lead, which is known to the State of California to cause cancer and birth defects or other reproductive harm. For more information go to www.P65Warnings.ca.gov.



NS 30-PBS Vacuum/Pressure Gauge

- ▶ Reads $\pm 30\text{cm H}_2\text{O}$ in **1cm** graduations
- ▶ Bottom **1/8" small bore tubing** connection



NS 30-TRS Vacuum/Pressure Gauge

- ▶ Reads $\pm 30\text{cm H}_2\text{O}$ in **1cm** graduations
- ▶ Rear **1/4" NPT** connection



NS 60-PBS Vacuum/Pressure Gauge

- ▶ Reads $\pm 60\text{cm H}_2\text{O}$ in **2cm** graduations
- ▶ Bottom **1/8" small bore tubing** connection

Replacement Crystal for Vacuum/Pressure Gauges

Use as replacement crystal for any Instrumentation Industries, Inc. NS Series Vacuum/Pressure Gauge.

NS-SC

- ▶ Acrylic
- ▶ Packaged: **Individually**



NS 60-TBS Vacuum/Pressure Gauge

- ▶ Reads $\pm 60\text{cm H}_2\text{O}$ in **2cm** graduations
- ▶ Bottom **1/4" NPT** connection



NS 60-TRS Vacuum/Pressure Gauge

- ▶ Reads $\pm 60\text{cm H}_2\text{O}$ in **2cm** graduations
- ▶ Rear **1/4" NPT** connection



NS 120-TRS Vacuum/Pressure Gauge

- ▶ Reads $\pm 120\text{cm H}_2\text{O}$ in **4cm** graduations
- ▶ Rear **1/4" NPT** connection

How they work

NS-S Series Vacuum/Pressure Gauges

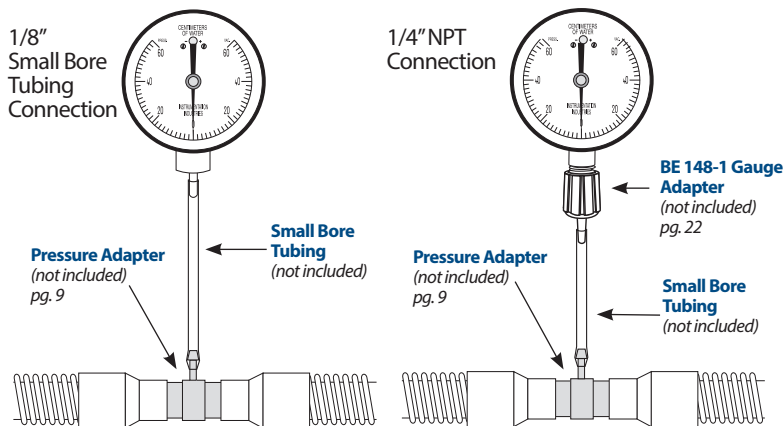

Pressure Gauge

Pressure Gauge provides accurate **0 to 120cm H₂O** pressure monitoring.

NS 120P-TRS Pressure Gauge

- ▶ Reads **0 to 120cm H₂O** in **2cm** graduations
- ▶ Rear **1/4" NPT** connection
- ▶ Internal Components: Aluminum, Brass, Copper Alloy & Steel
- ▶ Case: Acrylonitrile Butadiene Styrene (ABS)
- ▶ Crystal: Acrylic
- ▶ Packaged: **Individually**

**California customers see above info for NS 120P-TRS Pressure Gauge*



NIF Meters (Negative Inspiratory Force)

NIF Meters (Negative Inspiratory Force) capture a patient's best effort with a resettable pointer.

- ▶ Accurate
- ▶ Sturdy
- ▶ Reliable
- ▶ Resettable Recording Needle
- ▶ Incremental graduations as low as **1 cm H₂O**
- ▶ Easily **re-zeroed** for accuracy
- ▶ Internal Components: Aluminum, Brass, Copper Alloy & Steel
- ▶ Case: Acrylonitrile Butadiene Styrene (ABS)
- ▶ Crystal: Acrylic
- ▶ Packaged: **Individually**



NS-R Series NIF Meter info for California customers:



WARNING: These products can expose you to chemicals including Lead, which is known to the State of California to cause cancer and birth defects or other reproductive harm. For more information go to www.P65Warnings.ca.gov.



NS 30-PBR
NIF Meter

- ▶ Reads $\pm 30\text{cm H}_2\text{O}$ in **1cm** graduations
- ▶ Bottom **1/8"** small bore tubing connection
- ▶ Includes: **BE 148-6 Gauge Adapter**



NS 30-TRR
NIF Meter

- ▶ Reads $\pm 30\text{cm H}_2\text{O}$ in **1cm** graduations
- ▶ Rear **1/4"** NPT connection
- ▶ Includes: **BE 149-1 Gauge Adapter**



NS 60-PBR
NIF Meter

- ▶ Reads $\pm 60\text{cm H}_2\text{O}$ in **2cm** graduations
- ▶ Bottom **1/8"** small bore tubing connection
- ▶ Includes: **BE 148-6 Gauge Adapter**



NS 60-TBR
NIF Meter

- ▶ Reads $\pm 60\text{cm H}_2\text{O}$ in **2cm** graduations
- ▶ Bottom **1/4"** NPT connection
- ▶ Includes: **BE 149-1 Gauge Adapter**



NS 60-TRR
NIF Meter

- ▶ Reads $\pm 60\text{cm H}_2\text{O}$ in **2cm** graduations
- ▶ Rear **1/4"** NPT connection
- ▶ Includes: **BE 149-1 Gauge Adapter**



NS 120-TRR
NIF Meter

- ▶ Reads $\pm 120\text{cm H}_2\text{O}$ in **4cm** graduations
- ▶ Rear **1/4"** NPT connection
- ▶ Includes: **BE 149-1 Gauge Adapter**

Replacement Crystal for NIF Meters

Use as replacement crystal for any Instrumentation Industries, Inc. NS Series NIF Meter.

NS-RC

- ▶ Resettable Recording Needle
- ▶ Acrylic
- ▶ Packaged: **Individually**



Bacterial/Viral Filter

Bacterial/Viral Filter can be used to reduce microbiological contaminants.

BV 303 Bacterial/Viral Filter

- ▶ Low resistance hydrophobic HEPA filter
- ▶ Polypropylene
- ▶ Packaged: **1 or 25**



How they work

NS-R Series NIF Meters

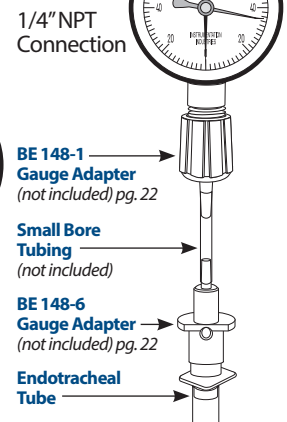
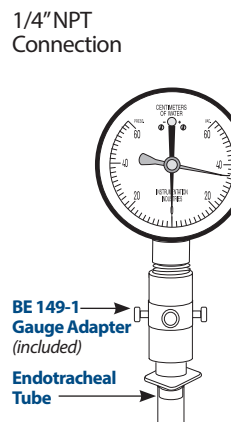
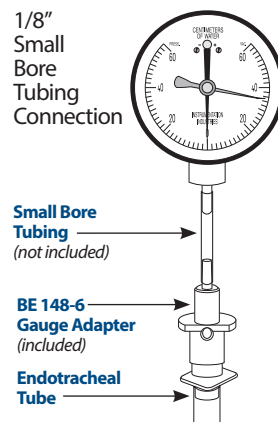

Gauge Accessories

Gauge Adapters

Gauge Adapters allow for easy remote inspiratory measurement. Designed for all **Instrumentation Industries, Inc. Vacuum/Pressure Gauges** and **NIF Meters**.

- ▶ Polycarbonate
- ▶ Gauge not included
- ▶ Packaged: **Individually**



BE 148-1 Gauge Adapter

- ▶ Changes a **1/4" NPT** connection to a **1/8" or 3/16" small bore tubing** connection



BE 148-6 Gauge Adapter

- ▶ **15mm I.D./22mm O.D.** x **1/8" or 3/16" small bore tubing** connection for remote inspiratory monitoring



BE 149-1 Gauge Adapter

- ▶ **15mm I.D./22mm O.D.** x **1/4" NPT** connection for inspiratory monitoring



Gauge Stand

Gauge Stand keeps a gauge upright, stable and easy to view. Specially designed for use with our **NS Series -PBR, -PBS, -TRR, & -TRS Vacuum/Pressure Gauges** and **NIF Meters**.

NS-GS Gauge Stand

- ▶ "No-skid" rubber feet
- ▶ Gauges are easily inserted
- ▶ Polystyrene Butadiene
- ▶ Gauge not included
- ▶ Packaged: **Individually**



Gauge Clamps

Gauge Clamps offer the convenience of mounting **Vacuum/Pressure Gauges** and **NIF Meters** in a variety of places.

- ▶ Small Bore Tubing Connection
- ▶ Precision-machined
- ▶ Anodized Aluminum & Steel
- ▶ Plated Brass Fittings
- ▶ Gauge not included
- ▶ Packaged: **Individually**



Gauge Clamps

Gauge Clamps mount **Rear 1/4" NPT**-threaded gauges securely to poles, incubators, ventilators, etc.

BE 148-5-2.5 Gauge Clamp

- ▶ Clamp opens **1" to 2 1/2"**



BE 148-5-3.5 Gauge Clamp

- ▶ Clamp opens **2 1/2" to 3 1/2"**

Gauge Pole Clamps

Gauge Pole Clamps mount **Rear 1/4" NPT**-threaded gauges securely to poles.

BE 148-5-1 Gauge Pole Clamp

- ▶ Fits Poles with a diameter of **3/4"**
- ▶ See pg. 16 for Replacement Knob



BE 148-5-2 Gauge Pole Clamp

- ▶ Fits Poles with a diameter of **3/4" to 1 1/2"**
- ▶ See pg. 16 for Replacement Knob

Rail-Mounted Gauge Clamp

Rail-Mounted Gauge Clamp mounts **Rear 1/4" NPT**-threaded gauges securely to rails.

RB 004 Rail-Mounted Gauge Clamp

- ▶ For use with Fairfield-style rails only
- ▶ See pg. 16 for Replacement Knob



Gauge Cover

Gauge Cover is designed to fit all of our **NS Series NIF Meters** and **Vacuum/Pressure Gauges** with the highest level of protection from falls, drops, vibrations, and other shocks.

NS-GC Gauge Cover

- ▶ Unique rubber "Clam Shell" design
- ▶ Ribbed for maximum shock protection
- ▶ Melt-Processible Rubber
- ▶ Gauge not included
- ▶ Packaged: **Individually**



Manual Jet Ventilators

Manual Jet Ventilators are lightweight, portable, durable, and essential for **EMS, Anesthesia, and Emergency** departments.

- ▶ Specially designed for use with our **Transtracheal Catheters** pg. 24
- ▶ Plated Brass Fittings
- ▶ Anodized Aluminum & Steel
- ▶ Packaged: **Individually**



BE 183-SUR

Manual Jet Ventilator w/Regulator & Gauge

- ▶ **Reusable**
 - ▶ Adjustable Regulator & Gauge*
 - ▶ On/Off Valve
 - ▶ **6-ft.** High Pressure Hose Assembly
- ▶ **Single Patient Use**
 - ▶ **4-ft.** Small Bore Tubing Assembly w/inline filter (see **BE 183-2** below for replacement)

Caution: *BE 183-SUR is designed to operate with pressure that does not exceed 50psi. Use **Regulator & Gauge** to assure operating pressure does not exceed 50psi.*

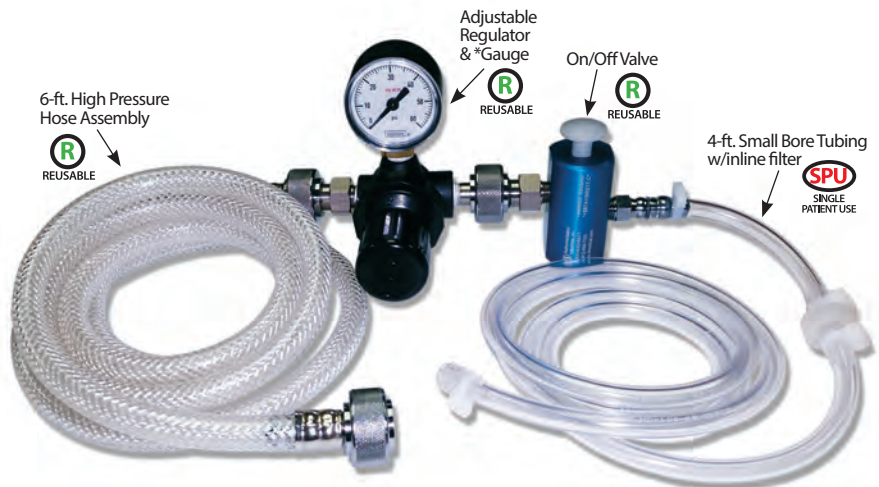

***BE 183-G Gauge** info for California customers:



WARNING: This product can expose you to chemicals including Lead, which is known to the State of California to cause cancer and birth defects or other reproductive harm. For more information go to www.P65Warnings.ca.gov.

BE 183-SU

Manual Jet Ventilator

- ▶ **Reusable**
 - ▶ On/Off Valve
 - ▶ **6-ft.** High Pressure Hose Assembly
- ▶ **Single Patient Use**
 - ▶ **4-ft.** Small Bore Tubing Assembly w/inline filter (see **BE 183-2** below for replacement)

Caution: *BE 183-SU is designed to operate directly from a gas source that does not exceed 50psi.*



Replacement Parts for Manual Jet Ventilators



BE 183-2

4-ft. Small Bore Tubing Assembly w/ Inline Filter

- ▶ For **BE 183-SU & BE 183-SUR**
- ▶ Packaged: **Individually**



BE 183-6

6-ft. High Pressure Hose Assembly

- ▶ For **BE 183-SU & BE 183-SUR**
- ▶ Standard Plated Brass Female DISS fittings on both ends
- ▶ Medical Grade PVC Tubing
- ▶ Packaged: **Individually**



BE 183-R

Regulator & Gauge

- ▶ For **BE 183-SUR**
- ▶ Packaged: **Individually**

*California customers see above info for **BE 183-G Gauge**



BE 183-G

Gauge

- ▶ For **BE 183-SUR**
- ▶ **0-60 psi**
- ▶ Must be used with regulator
- ▶ Packaged: **Individually**

*California customers see above info for **BE 183-G Gauge**

Transtracheal Catheters

Transtracheal Catheters provide tracheal access for our **Manual Jet Ventilators**. Attached **syringe** helps to determine correct needle placement in the trachea by air aspiration.

- ▶ Packaged sterile — Ready to Use
- ▶ Unopened packages have a shelf life of a minimum of **2 years** from purchase
- ▶ Works with **BE 183-SUR** & **BE 183-SU Manual Jet Ventilators**
- ▶ Foam **Neck Tape** with **Velcro Lock**
- ▶ Attached **Syringe**
- ▶ Packaged: **Individually**



ACU 1060.1
Transtracheal Catheter
▶ **13G** — Adult

ACU 1060.2
Transtracheal Catheter
▶ **14G** — Child

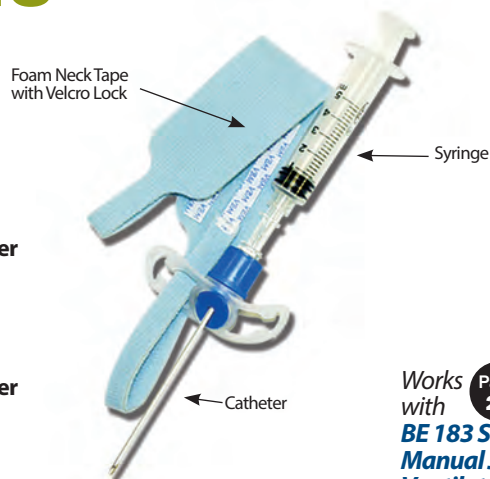

Works with **Page 23**
BE 183 Series
Manual Jet Ventilators

Oropharyngeal Airways

Oropharyngeal Airways keep the airway open by holding the tongue forward and out of the way.

- ▶ **Flange** rests against front teeth to prevent swallowing airway
- ▶ **"I Beam" Shape** allows a suction catheter to be used on either side
- ▶ Low Density Polyethylene
- ▶ Packaged: **10** or **50**
(Also available, a package of **One each** of all **seven SH 77 Series** sizes)



SH 77 Series

Non-Center-Vented Oropharyngeal Airways

| | | | | |
|-----|----------------|--------------|---|-------|
| A — | SH 77-1 | Neonatal | - | 40mm |
| B — | SH 77-2 | Infant | - | 50mm |
| C — | SH 77-3 | Small Child | - | 60mm |
| D — | SH 77-4 | Child | - | 70mm |
| E — | SH 77-5 | Small Adult | - | 80mm |
| F — | SH 77-6 | Medium Adult | - | 90mm |
| G — | SH 77-7 | Large Adult | - | 100mm |

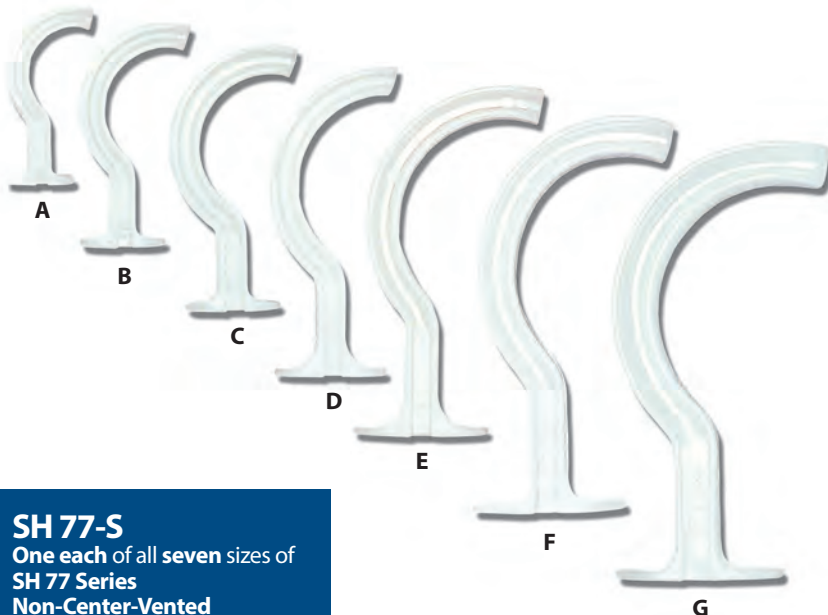

SH 77-S
One each of all seven sizes of
SH 77 Series
Non-Center-Vented
Oropharyngeal Airways

Did you know?

Since 2010, solar panels installed on our building have been producing electricity that helps to off-set the energy used in manufacturing our products!

In 2018, our Quality System was certified to ISO 13485:2016 with MDSAP for the United States and Canada.



Order by Fax ▶ 1-877-633-8661

Laryngoscope Blades & Handles

Laryngoscope Blades

Laryngoscope Blades are available in two types, **Macintosh** (*curved*) and **Miller** (*straight*) in a variety of sizes. All blades are lighted.

- ▶ Adapts to handles with **Howland locks**
- ▶ Replacement Bulbs available
- ▶ Stainless Steel
- ▶ Packaged: **Individually**



Macintosh Blades

Curved laryngoscope blades



AM MAC Series Macintosh Blades

- A — **AM MAC-1** Size 1 - 87mm
- B — **AM MAC-2** Size 2 - 108mm
- C — **AM MAC-3** Size 3 - 130mm
- D — **AM MAC-4** Size 4 - 158mm

Miller Blades

Straight laryngoscope blades



AM MIL Series Miller Blades

- A — **AM MIL-0** Size 0 - 75mm
- B — **AM MIL-1** Size 1 - 102mm
- C — **AM MIL-1.5** Size 1.5 - 127mm
- D — **AM MIL-2** Size 2 - 155mm
- E — **AM MIL-3** Size 3 - 195mm
- F — **AM MIL-4** Size 4 - 205mm

Laryngoscope Handles

Laryngoscope Handles have a knurled finish for better grip.

- ▶ Fits all of our **Macintosh & Miller Blades** and adapts to most "**hook-on**" blades
- ▶ Stainless Steel
- ▶ Packaged: **Individually**



◀ **SM-MH**
Medium Laryngoscope Handle
▶ Uses 2 "C" batteries

SM-PH ▶
Penlite Laryngoscope Handle
▶ Uses 2 "AA" batteries

Macintosh & Miller Blade Replacement Bulbs

- ▶ Packaged: **Individually**

Replacement Bulbs for: **AM MAC-1, AM MAC-2, AM MIL-0, AM MIL-1, AM MIL-1.5, AM MIL-2, AM MIL-3**

- SM-501** Small Frosted
- SM-503** Small Pre-Focused

Replacement Bulbs for: **AM MAC-3, AM MAC-4, AM MIL-4**

- SM-502** Large Frosted
- SM-504** Large Pre-Focused
- SM-505** Parabolic Reflector



Endotracheal Tube Changers

Endotracheal Tube Changers provide a simple technique for changing endotracheal tubes.

- ▶ No Laryngoscope needed!
- ▶ Rigid but flexible
- ▶ **Rounded tips** allow smooth, trauma-less insertion
- ▶ **Graduated marks** for easy and accurate placement of new tube
- ▶ Available in **nine** sizes for **2.5mm I.D.** to **7.5mm I.D.** endotracheal tubes
- ▶ High Density Polyethylene
- ▶ Packaged: **10**
(Also available, a package of **one each** of all nine **JEM Series sizes**)



JEM Series Endotracheal Tube Changers

- A — JEM 400** fits **7.5mm I.D.** tubes
Markings: **Black** — Length: **29"**
- B — JEM 370** fits **7.0mm I.D.** tubes
Markings: **Blue** — Length: **27.5"**
- C — JEM 365** fits **6.5mm I.D.** tubes
Markings: **Green** — Length: **26.5"**
- D — JEM 360** fits **6.0mm I.D.** tubes
Markings: **Magenta** — Length: **26"**
- E — JEM 355** fits **5.5mm I.D.** tubes
Markings: **Black** — Length: **25"**
- F — JEM 350** fits **5.0mm I.D.** tubes
Markings: **Blue** — Length: **23"**
- G — JEM 340** fits **4.0mm I.D.** tubes
Markings: **Magenta** — Length: **19.5"**
- H — JEM 330** fits **3.0mm I.D.** tubes
Markings: **Blue** — Length: **16.5"**
- I — JEM 325** fits **2.5mm I.D.** tubes
Markings: **Black** — Length: **15"**

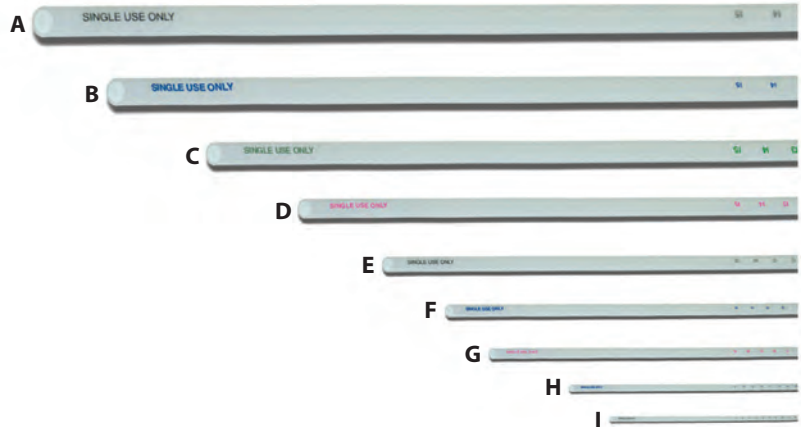

JEM 401

One each of all nine sizes of JEM Series Endotracheal Tube Changers

Product Info

Size is clearly marked

Graduated marks for easy, accurate placement of new tube



How they work

JEM Series Endotracheal Tube Changer

The **JEM Endotracheal Tube Changer** is placed into the **Endotracheal Tube**. The guide mark location is noted.

The **Endotracheal Tube** is removed by passing it over the **JEM Endotracheal Tube Changer**. (Figure A)

The replacement **Endotracheal Tube** is inserted over the **JEM Endotracheal Tube Changer**. Guide marks facilitate accurate placement of the new **Endotracheal Tube**. (Figure B)

The **JEM Endotracheal Tube Changer** is then removed.

Endotracheal Tube Removal

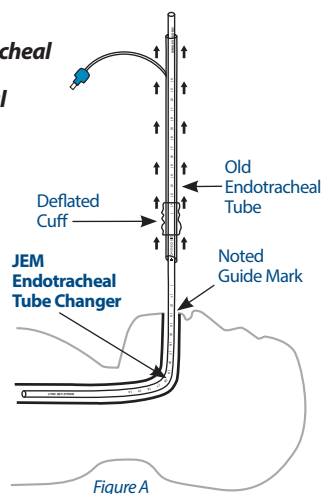

Endotracheal Tube Insertion

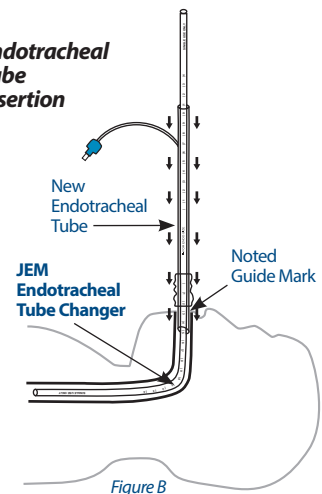

Pilot Tube Repair Kit

Pilot Tube Repair Kit allows cuff re-inflation on an **endotracheal** or **tracheostomy** tube with a damaged pilot line. Kit includes **Pilot Tube Repair Device** and **10 cc/mL Syringe**.

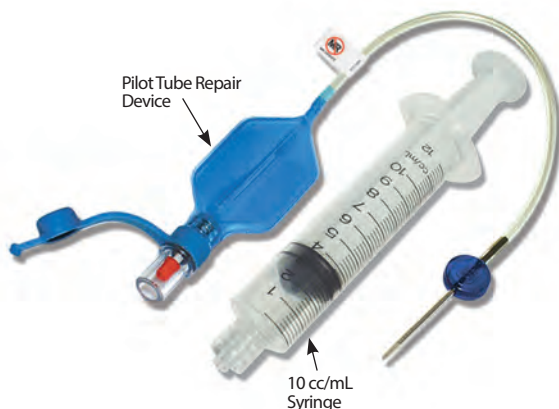

BE 409 Pilot Tube Repair Kit

- ▶ Essential for all ICU and emergency departments
- ▶ For use with endotracheal and tracheostomy tubes
- ▶ Includes **10 cc/mL Syringe** for cuff re-inflation
- ▶ Fits pilot lines of most tubes: **0.032 in. I.D. (21g)** to **0.050 in. I.D. (18g)**
- ▶ Stainless Steel Tapered Needle
- ▶ Packaged: **5 or 10**



How they work

BE 409 Pilot Tube Repair Kit

Pilot Tube is cut between damaged area and patient. (Figure A)
Pilot Tube Repair Device's Tapered Needle is inserted into cut **Pilot Tube**. (Figure B)
10 cc/mL Syringe is inserted into **Pilot Tube Repair Device's Inflation Port** (Figure C), or...into **Cuff Pressure Monitor** inserted into **Pilot Tube Repair Device's Inflation Port** (Figure D). Cuff is inflated gradually.

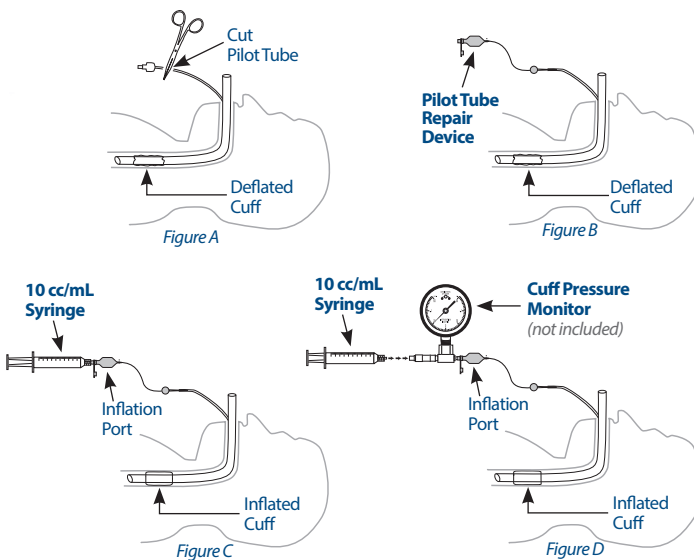

Cuff Pressure Monitors

Cuff Pressure Monitors provide a simple, effective, and economical way to avoid excessive cuff pressure.



- ▶ Packaged: **Individually**



NS 60-TBS-CP Cuff Pressure Monitor

- ▶ Reads $\pm 60\text{cm H}_2\text{O}$ in **2cm** graduations
- ▶ Bottom Mount **1/4" NPT Gauge & Adapter**
- ▶ Anodized Aluminum & Steel Adapter



NS 60-TRS-CP Cuff Pressure Monitor

- ▶ Reads $\pm 60\text{cm H}_2\text{O}$ in **2cm** graduations
- ▶ Rear Mount **1/4" NPT Gauge & Adapter**
- ▶ Anodized Aluminum & Steel Adapter



BE 148-4 Cuff Pressure Monitor Adapter

- ▶ Fits **1/4" NPT Gauges**
- ▶ Anodized Aluminum & Steel

How they work

NS Series Cuff Pressure Monitors (including BE 148-4)

Cuff Pressure Monitor Adapter is inserted into the **Endotracheal Tube's Pilot Line Inflation Valve**.

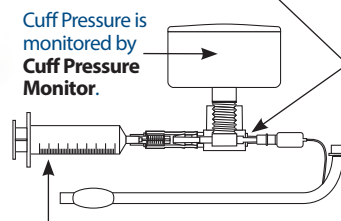

If cuff pressure reading is not optimal, a **10cc Syringe (not included)** is inserted into the **Cuff Pressure Monitor Adapter Valve** to increase or decrease pressure.

NS 60-TBS-CP/NS 60-TRS-CP Gauge info for California customers:
WARNING: These products can expose you to chemicals including Lead, which is known to the State of California to cause cancer and birth defects or other reproductive harm. For more information go to www.P65Warnings.ca.gov.

Anesthesia Flush Plug

Anesthesia Flush Plug provides a simple way to plug an **anesthesia machine breathing circuit** for flushing or other maintenance.

AM 100P

Anesthesia Flush Plug

- ▶ Can help reduce the possibility of exposure of personnel to anesthetic gases
- ▶ Protects anesthesia machine or mask from dust and debris when not in use
- ▶ Keeps ventilator circuits clean when not in use
- ▶ High Density Polyethylene
- ▶ Packaged: **25** or **50**



15mm O.D.

How they work

AM 100P — Anesthesia Flush Plug

Typical **Anesthesia Machine Breathing Circuit with Gas Sampling Elbow and Anesthesia Mask.**

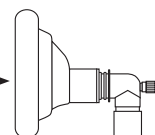

Anesthesia Flush Plug can be used in multiple circuit locations.

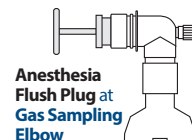

Anesthesia Flush Plug at Gas Sampling Elbow



Anesthesia Flush Plug at Y-Piece

Anesthesia Holster

Anesthesia Holster is used to store soiled **laryngoscope blades**, **suction tips**, etc. during intubation. Uniquely designed to attach to the bed or table's side rail using a hooking-style clip built to fit standard operating room beds currently in use.

CI-55

Anesthesia Holster

- ▶ Dimensions:
 - **2.125 in.** (54mm) wide
 - **2.125 in.** (54mm) deep
 - **5.875 in.** (149mm) high
- ▶ Helps prevent cross-contamination and pathogen transmission in the anesthesia work area
- ▶ Polypropylene
- ▶ Patent Pending
- ▶ Packaged: **10** or **20**



Large enough to hold laryngoscope blades, without being intrusive!



Creatively-engineered clip keeps unit down and out of way of work area.

Essential for anesthesia work areas!

From start to finish, we're your...

Medical Product Outsourcing Company

Plastic • Silicone Rubber • Metal

For over **50** years, some of the world's leading medical companies have relied on us to produce millions of **High Quality Medical Products** *...right here in the USA!*

We work in accordance with **ISO 13485:2016** and the **FDA's Quality System Regulations**. We can also assist you in attaining **Regulatory** approval for your medical products. With our in-house **Engineering, Tool & Die, Machining, Injection Molding, Assembly, Quality Control** and **Regulatory** departments, we have complete control over production and costs.

From single prototypes to full production runs, we have the facility and staff to meet your needs!

Design & Engineering
Tool & Die
Injection Molding
Machining
Laser Marking

Assembly
Ultrasonic Welding
Quality Assurance
Packaging
Graphic Design



MedicalOEM

A Division of Instrumentation Industries, Inc.

1-800-633-8577

iiioem.com

Breathing Bags

Breathing Bags are made of neoprene, and have a **22mm I.D.** connection. They can be used in closed or semi-closed (with CO₂ absorber) rebreathing circuits. **Not made with natural rubber latex.**

Three-pleat style



- ▶ Green Neoprene, Polyisoprene, & Natural Thermoplastic Rubber

KC 00.5N

.5-Liter Breathing Bag

- ▶ Packaged: **Individually**

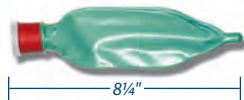

SG 066-2N

1-Liter Breathing Bag

- ▶ Packaged: **1 or 25**

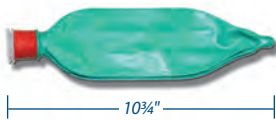

KC 002N

2-Liter Breathing Bag

- ▶ Packaged: **Individually**



KC 003N

3-Liter Breathing Bag

- ▶ Packaged: **Individually**

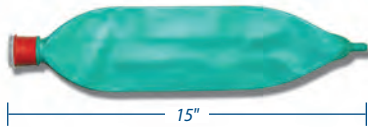

Two-pleat style



- ▶ Green Neoprene, Polyisoprene, & Natural Thermoplastic Rubber

KC 00.5N-2P

.5-Liter Breathing Bag

- ▶ Packaged: **Individually**

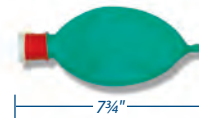

SG 066-2N-2P

1-Liter Breathing Bag

- ▶ Packaged: **1 or 25**

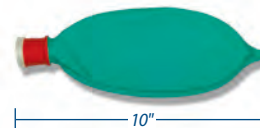

KC 002N-2P

2-Liter Breathing Bag

- ▶ Packaged: **Individually**

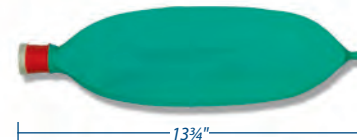

KC 003N-2P

3-Liter Breathing Bag

- ▶ Packaged: **Individually**

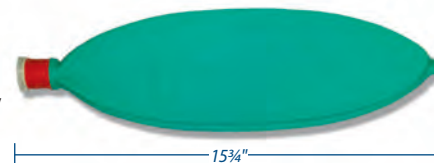

High Pressure Hose Assemblies

High Pressure Hose Assemblies connect oxygen remotely. They deliver a high pressure flow of oxygen from a flowmeter or any delivery source. **Not made with natural rubber latex.**

- ▶ Standard Plated Brass Female DISS fittings on both ends
- ▶ Medical Grade PVC Tubing
- ▶ Packaged: **Individually**



BE 1000-3

4.5-ft. High Pressure Hose Assembly

- ▶ Replacement for: **BE 3000-PA/PS & RA/RS O₂ Instant Flow Valves**



BE 183-6

6-ft. High Pressure Hose Assembly

- ▶ Replacement for: **BE 183 Series Manual Jet Ventilators**

Package Insert/User Instruction sheets for our products are available online at iiimedical.com

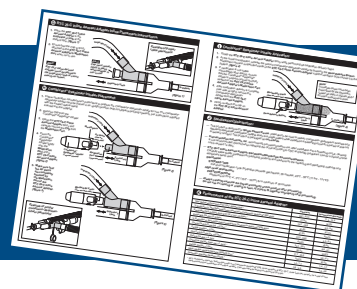

O₂ Instant Flow Valves

O₂ Instant Flow Valves stop the wasteful practice of oxygen dumping, while assuring the flow of oxygen to resuscitation bags. They are essential where O₂ to a **resuscitation bag** is always on, but used only when needed.

- ▶ For use with adult, pediatric, or neonatal resuscitation bags weighing more than **3 oz.** (90 g)
- ▶ Flowmeter is not affected in any way!
- ▶ Standard Plated Brass DISS Fittings
- ▶ Plated Brass Small Bore Tubing Bubble Fittings
- ▶ Anodized Aluminum & Steel
- ▶ Packaged: **Individually**



How they work

O₂ Instant Flow Valves

When **resuscitation bag** is placed on **O₂ Instant Flow Valve** arm, oxygen flow is stopped.

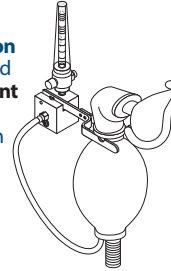

When **resuscitation bag** is removed from **O₂ Instant Flow Valve** arm, oxygen flow resumes.

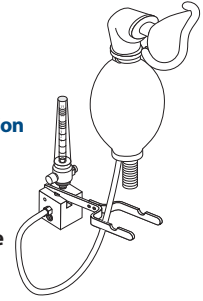

Flowmeter-Mounted

(Direct Connection to Flowmeter)



BE 3000-FA Flowmeter-Mounted O₂ Instant Flow Valve

- ▶ **Forked Arm**
- ▶ Does not require Bag Hanger

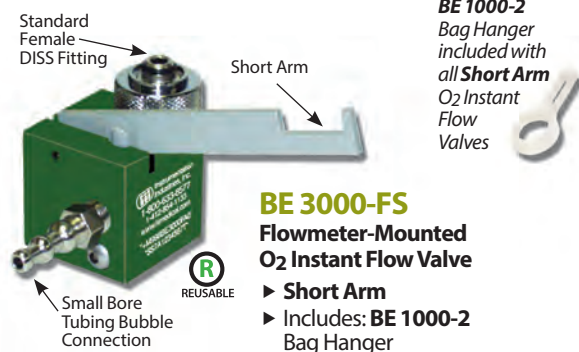

BE 3000-FS Flowmeter-Mounted O₂ Instant Flow Valve

- ▶ **Short Arm**
- ▶ Includes: **BE 1000-2** Bag Hanger

BE 1000-2
Bag Hanger
included with
all **Short Arm**
O₂ Instant
Flow Valves

Pole-Mounted

(Remote Connection to Flowmeter)

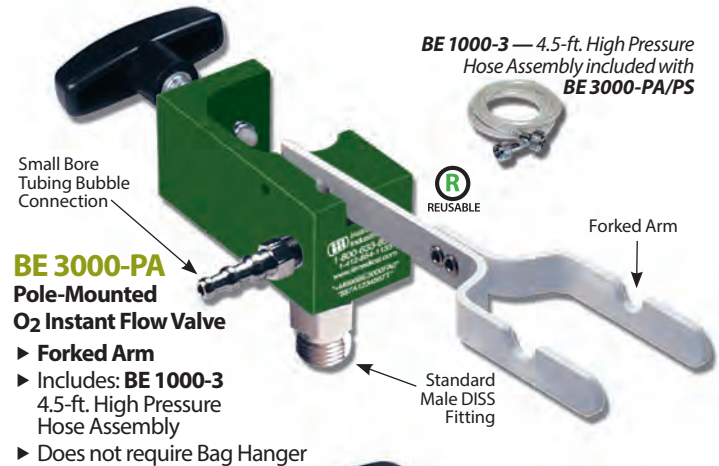

BE 3000-PA Pole-Mounted O₂ Instant Flow Valve

- ▶ **Forked Arm**
- ▶ Includes: **BE 1000-3** 4.5-ft. High Pressure Hose Assembly
- ▶ Does not require Bag Hanger

BE 1000-3 — 4.5-ft. High Pressure
Hose Assembly included with
BE 3000-PA/PS

BE 3000-PS Pole-Mounted O₂ Instant Flow Valve

- ▶ **Short Arm**
- ▶ Includes: **BE 1000-3** 4.5-ft. High Pressure Hose Assembly
- ▶ Includes: **BE 1000-2** Bag Hanger

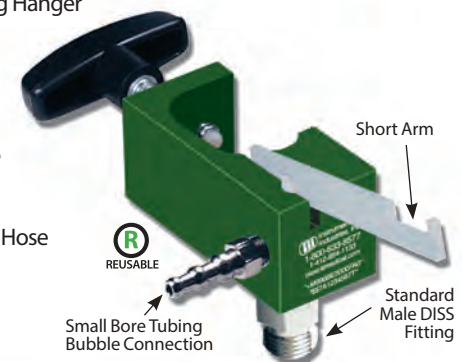

Bag Hangers

O₂ Instant Flow Valve **Bag Hangers** attach resuscitation bags to **Short Arm O₂ Instant Flow Valves**. **Not made with natural rubber latex.**

BE 1000-2 Bag Hanger

- ▶ Silicone Rubber
- ▶ Packaged: **Individually**



REUSABLE

NP 1000-2D Bag Hanger

- ▶ Neoprene
- ▶ Packaged: **50**



SPU
SINGLE
PATIENT USE

O₂ Flow Selector Valve

O₂ Flow Selector Valve allows switching between **O₂ therapy** and **SVN aerosol** treatment using one O₂ outlet. Flow is redirected at the “**Flick of a Switch!**”

SC 603-A O₂ Flow Selector Valve

- ▶ Plated Brass Standard DISS fittings
- ▶ Plated Brass Small bore tubing bubble fitting
- ▶ Polycarbonate
- ▶ Internal Brass Valve
- ▶ Packaged: **Individually**

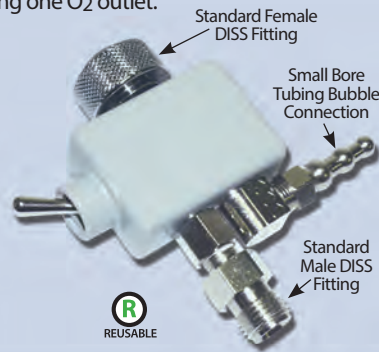

How they work

SC 603-A O₂ Flow Selector

Set **Toggle Switch** to desired position:

Position 1
SVN Aerosol Treatment

Position 2
Humidified Oxygen

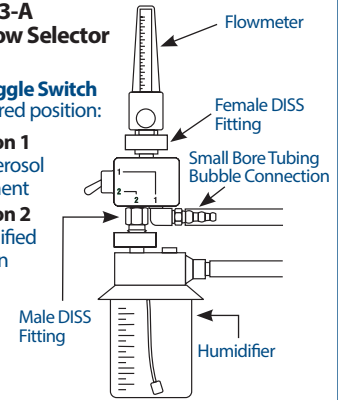

Rail-Mounted

(Remote Connection to Flowmeter)



BE 3000-RA Rail-Mounted O₂ Instant Flow Valve

- ▶ **Forked Arm**
- ▶ Includes:
BE 1000-3
4.5-ft High Pressure Hose Assembly
- ▶ Does not require Bag Hanger
- ▶ Does not fit on rails flush to wall

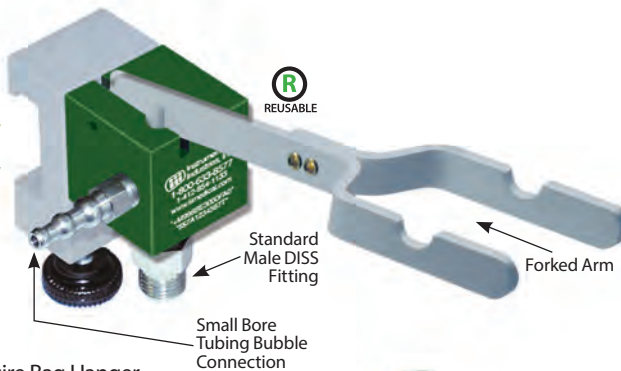

BE 3000-RS Rail-Mounted O₂ Instant Flow Valve

- ▶ **Short Arm**
- ▶ Includes:
BE 1000-3
4.5-ft High Pressure Hose Assembly
- ▶ Includes:
BE 1000-2
Bag Hanger
- ▶ Does not fit on rails flush to wall

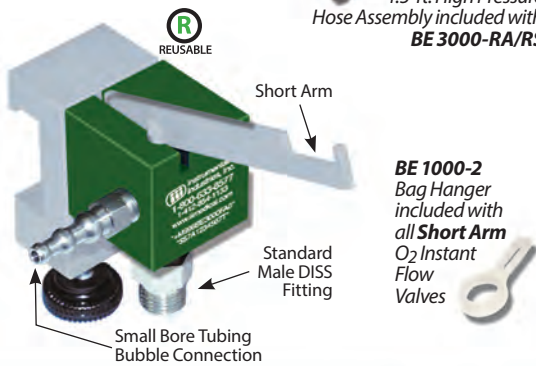

Replacement Parts

4.5-ft. High Pressure Hose Assembly

BE 1000-3

Replacement 4.5-ft High Pressure Hose Assembly

- ▶ Replacement for:
BE 3000-PA & PS
BE 3000-RA & RS
- ▶ See pg. 29 for more info
- ▶ Packaged: **Individually**



We did the *math...*
you do the *saving!*

$$\begin{aligned}
 & \$1.40/100 \text{ ft}^3 \quad \text{O}_2 \text{ cost} \\
 & \quad \times 15 \text{ lpm} \quad \text{O}_2 \text{ flow rate} \\
 & \quad \times 0.0353 \quad \text{Conversion of liters to ft.}^3 \\
 & \quad \times 175,200^* \quad \text{Minutes per year of} \\
 & \quad \text{wasted O}_2 \text{ to a} \\
 & \quad \text{resuscitation bag} \\
 & = \mathbf{\$1,299} \quad \text{Annual savings} \\
 & \quad \text{per bed!}
 \end{aligned}$$

* Assuming the O₂ is not needed for various reasons 1/3 of the year. Your results may vary.

Constantly flowing oxygen without waste!

Wall Mount

Wall Mount allows a **Rail-Mounted O₂ Instant Flow Valve (BE 3000-RA/RS)** to be used in rooms without installed rails.

BE 3000-WM Wall Mount

- ▶ Can be moved from room to room
- ▶ Anodized Aluminum
- ▶ Packaged: **Individually**



Barbed Tubing Adapters

("Christmas Tree" Connectors)

Barbed Tubing Adapters are precision-engineered to help in delivering prescribed gas flow from flowmeters. Poorly manufactured or improperly attached **Barbed Tubing Adapters** can compromise prescribed gas flows by leaking.

- ▶ Fits standard **9/16-18 (DISS 1240)** outlet
- ▶ Six colors for easy color coding
- ▶ Packaged: **25** or **50**



SH 74-C Barbed Tubing Adapter

- ▶ Clear
- ▶ Acrylic Copolymer



SH 74-G Barbed Tubing Adapter

- ▶ Green
- ▶ ABS (Acrylonitrile Butadiene Styrene)



SH 74-W Barbed Tubing Adapter

- ▶ White
- ▶ ABS (Acrylonitrile Butadiene Styrene)



SH 74-Y Barbed Tubing Adapter

- ▶ Yellow
- ▶ ABS (Acrylonitrile Butadiene Styrene)



SH 74-BL Barbed Tubing Adapter

- ▶ Blue
- ▶ ABS (Acrylonitrile Butadiene Styrene)



SH 74-BK Barbed Tubing Adapter

- ▶ Black
- ▶ ABS (Acrylonitrile Butadiene Styrene)



Swivel Barbed Tubing Adapters

(Swivel "Christmas Tree" Connectors)

Swivel Barbed Tubing Adapters swivel **360°** until tightened to help with installation.

- ▶ Swivels **360°** until tightened
- ▶ Fits standard **9/16-18 (DISS 1240)** outlet
- ▶ Six colors for easy color coding
- ▶ ABS (Acrylonitrile Butadiene Styrene)
- ▶ Packaged: **25** or **50**



Are your current **Christmas Tree Connectors** leaking?...
test them

1. Turn flowmeter on.
2. Set flow to **3 l/min**.
3. Pinch patient end of tube.
4. If ball falls to **zero**, it is **NOT** leaking.
5. If ball continues to float at any level, it **IS** leaking.

If yours are leaking, try ours!

SH 75-C Swivel Barbed Tubing Adapter

- ▶ Clear



SH 75-G Swivel Barbed Tubing Adapter

- ▶ Green



SH 75-W Swivel Barbed Tubing Adapter

- ▶ White



SH 75-Y Swivel Barbed Tubing Adapter

- ▶ Yellow



SH 75-BL Swivel Barbed Tubing Adapter

- ▶ Blue



SH 75-BK Swivel Barbed Tubing Adapter

- ▶ Black



5-in-1 Connector

5-in-1 Connector helps in connecting various sizes of tubing or to extend the length of tubing.

- ▶ Barbed edges help prevent disconnects
- ▶ Fits tubing with inside diameters from 3/16" to 7/16"
- ▶ Polypropylene
- ▶ Packaged: 25 or 50



SH 7-2
5-in-1 Connector

Flowmeter/Air Compressor Adapters

Flowmeter/Air Compressor Adapters connect a flowmeter or an air compressor directly to 22mm I.D. tubing. Can be used with high gas flows for CPAP.

- ▶ Standard Plated Brass Female DISS Fitting
- ▶ Security chain to prevent loss
- ▶ Anodized Aluminum & Steel
- ▶ Packaged: **Individually**

CB 23
Flowmeter/
Air Compressor
Adapter



22mm O.D.

CB 23-1
Flowmeter/
Air Compressor
Adapter



22mm O.D.

- ▶ Includes:
O₂ Inlet Port
Fits 1/8" I.D.
tubing

Flowmeter Security Devices

Flowmeter Security Devices can help eliminate the misplacement of flowmeters. They attach flowmeters securely to an oxygen wall plate.

- ▶ Packaged: **Individually**



BE 167
Flowmeter Security Wire



- ▶ 8" long
- ▶ Steel Components & Nylon-Coated Wire



BE 168
Flowmeter Security Chain



- ▶ 8½" long
- ▶ Stainless Steel Components

How they work

Flowmeter Security Devices

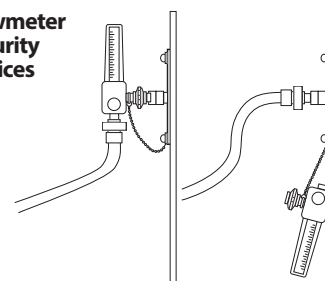

O₂ Tank Wrench



O₂ Tank Wrench is made of plated steel. 12" security cable helps prevent misplacement of wrenches.

- ▶ Packaged: **Individually**



BE 169
O₂ Tank Wrench w/12" Security Cable



- ▶ Steel Components & Nylon-Coated Cable



BE 169-W
O₂ Tank Wrench



- ▶ Plated Steel



BE 169-C
12" Security Cable



- ▶ Steel Components & Nylon-Coated Cable

How they work

O₂ Tank Wrench

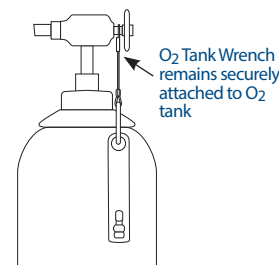

O₂ Tank Wrench remains securely attached to O₂ tank

Mask/Filter Storage Boxes

Mask/Filter Storage Boxes provide immediate availability of resuscitator bags, airways, masks, filters, eye protection, etc.

- ▶ Available in **3 sizes**
- ▶ Includes **5 Red & 5 Yellow Replaceable Safety Seal Locks** which ensure the integrity of box contents
- ▶ Contents clearly visible
- ▶ Can be mounted on any smooth surface
- ▶ Clear acrylic with opaque backing
- ▶ Packaged: **Individually**



REUSABLE

BE 4500 Mask/Filter Storage Box

- ▶ 9¼" High
- ▶ 6" Wide
- ▶ 4½" Deep



REUSABLE

BE 4500-18D Mask/Filter Storage Box

- ▶ 18" High
- ▶ 6" Wide
- ▶ 5¼" Deep



REUSABLE

BB 4500-20D Mask/Filter Storage Box

- ▶ 20" High
- ▶ 8" Wide
- ▶ 6" Deep

Replacement Parts

Replacement Safety Seal Locks for all of our Mask/Filter Storage Boxes.

- ▶ Helps ensure box integrity
- ▶ For: **BE 4500, BE 4500-18D, & BB 4500-20D**
- ▶ Packaged: 5



BE 4501 Replacement Safety Seal Locks

- ▶ Red

SPU
SINGLE
PATIENT
USE

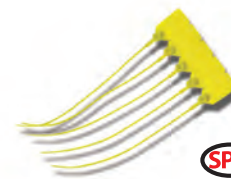

BE 4502 Replacement Safety Seal Locks

- ▶ Yellow

SPU
SINGLE
PATIENT
USE



All of our products
are available online!
iiimedical.com



Order Online ▶ iiimedical.com

"NO SMOKING - OXYGEN IN USE" Sign

"NO SMOKING - OXYGEN IN USE" Sign is sold in multiples for use throughout your facility.

BE 352

"NO SMOKING - OXYGEN IN USE" Sign

- ▶ 5" x 8"
- ▶ Red on white for high visibility
- ▶ Inexpensive way to display "No Smoking" sign where oxygen is in use
- ▶ **English** one side / **Spanish** one side
- ▶ White Vinyl
- ▶ Packaged: **50** or **100**



Magnetic "OXYGEN - NO SMOKING" Signs

Magnetic "OXYGEN - NO SMOKING" Signs are sold in multiples for use throughout your facility.

- ▶ 1¾" x 8"
- ▶ Red on white for high visibility
- ▶ Available in **English** or **Spanish**
- ▶ Packaged: **10**

BE 354
Magnetic "OXYGEN — NO SMOKING" Sign

- ▶ English



BE 355
Magnetic "OXIGENO — NO FUMAR" Sign

- ▶ Spanish



Reversible Screwdriver

Reversible Screwdriver has one **flathead** end and one **Phillips** end...very handy for re-zeroing gauges or making fine adjustments.

EH 2

Reversible Screwdriver

- ▶ 5" long
- ▶ Pocket clip
- ▶ Plated Steel
- ▶ Packaged: **1** or **5**



How are we doing?

Tell us what we're doing right... or what we need to do better.



feedback@iiimedical.com

Breast Marker

Breast Marker is used to assist in nipple placement during breast re-constructive surgery. A temporary impression is made by pressing the **Breast Marker** onto skin with a gentle rotating motion.

NL 100

Breast Marker

- ▶ Two marking edges: **38mm & 42mm**
- ▶ Methylene blue may be used as a marking agent
- ▶ Polycarbonate
- ▶ Packaged: **25**



Nose Clip

Nose Clip helps to hold a patient's nostrils closed while administering treatment or during clinical testing.

SH 7-47

Nose Clip

- ▶ Acetal & Polyvinyl Chloride (PVC)
- ▶ Packaged: **50 or 100**



Accessories for Discontinued, Instrumentation Industries, Inc. Gauges with Metal Cases

BE 147-GC

Blue Gauge Cover w/Long Neck



- ▶ Fits Vacuum/Pressure Gauges: **BE 147, BE 147-30, BE 148, BE 148-30, & BE 148-120**
- ▶ Fits NIF Meters: **BE 147-149, BE 149, & BE 149-120**
- ▶ Packaged: **Individually**

BE 147-GCV

Blue Gauge Cover w/Short Neck



- ▶ Fits Vacuum/Pressure Gauges: **BE 147, BE 147-30, BE 148, BE 148-30, & BE 148-120**
- ▶ Fits NIF Meters: **BE 147-149, BE 149, & BE 149-120**
- ▶ Packaged: **Individually**

BE 148-2

Screw-on Smooth Crystal



- ▶ Replacement Crystal for Vacuum/Pressure Gauges: **BE 147, BE 147-30, BE 148, BE 148-30, & BE 148-120**
- ▶ Packaged: **Individually**

Do you have an idea for a new medical product?

Contact us.

We're always on the lookout for ideas that can help in patient treatment.

1-800-633-8577
sales@iiimedical.com



Product Index

Products in **Bold** are made in the **USA!**

A

ACU 1060.1.....24
 ACU 1060.2.....24
ADP 150..... 10
AM 100P.....28
 AMMACSeries.....25
 AMMILSeries.....25

B

BB 4500-20D.....34
BE 1000-2.....30
 BE 1000-3.....29,31
BE 101-00-1426..... 10
BE 101-00-3443..... 10
BE 102.....17
BE 105-101-40..... 9
BE 105-2222..... 6
BE 105-2X22..... 7
BE 105-2X22D.....7
BE 105-40..... 9
BE 105-7.....12
BE 105-7-1.....12
BE 105-8.....12
BE 106..... 6
BE 114-1.....16
BE 114-2.....16
BE 114-5.....16
BE 114-5K.....16
BE 114-K.....16
BE 114-5TB.....17
 BE 115-2N.....14
BE 115-3B.....14
BE 115-3L.....14
BE 117.....12
BE 117-W..... 7
BE 120-22D..... 6
BE 120-AKW..... 6
BE 122-24.....16
BE 122-2TB.....17
BE 122-2TSB.....17
BE 122-30.....16
BE 122-S.....16
BE 125..... 7
BE 125-1..... 7
BE 125-1T..... 7
BE 125-1TD..... 7
BE 127.....11
BE 127-40.....11
BE 127-7.5.....11
BE 127-7.5-40.....11
BE 130.....13
BE 130-22B.....13

BE 130-23BB..... 13
BE 131.....13
BE 139..... 9
BE 139-105..... 8
BE 142.....13
BE 142-3.....13
BE 145-1522P..... 10
BE 145-2230P..... 10
BE 145-2P.....10
BE 147-GC.....36
BE 147-GCV.....36
BE 148-1.....22
BE 148-2.....36
 BE 148-4.....27
BE 148-5-1.....22
BE 148-5-2.....22
BE 148-5-2.5.....22
BE 148-5-3.5.....22
BE 148-6.....22
BE 149-1.....22
 BE 150-5G.....15
 BE 150-5LF.....15
BE 16-2..... 7
BE 167.....33
BE 168.....33
 BE 169.....33
 BE 169-C.....33
 BE 169-W.....33
 BE 183-2.....23
BE 183-6.....23,29
 BE 183-G.....23
 BE 183-R.....23
 BE 183-SU.....23
 BE 183-SUR.....23
BE 190..... 8
BE 191..... 8
BE 192..... 8
BE 193..... 8
BE 195-1522A..... 8
BE 195-A.....14
BE 215-2A.....14
BE 30-115-B.....14
BE 30-115-BL.....14
BE 30-142.....13
BE 30-142-3.....13
BE 3000-FA.....30
BE 3000-FS.....30
BE 3000-PA.....30
BE 3000-PS.....30
BE 3000-RA.....31
BE 3000-RS.....31
BE 3000-WM.....31

BE 352.....35
BE 354.....35
BE 355.....35
 BE 409.....27
BE 40A..... 9
BE 40H..... 9
BE 4500.....34
BE 4500-18D.....34
BE 4501.....34
BE 4502.....34
 BV 303.....21

C

CAP-S.....11
CB 23.....33
CB 23-1.....33
 CI-55.....28

E

EH 2.....35

J

JEM Series.....26

K

KC 00.5N.....29
KC 00.5N-2P.....29
KC 002N.....29
KC 002N-2P.....29
KC 003N.....29
KC 003N-2P.....29
 KC 1.....16
KC 10.....17
KC 1010..... 7
KC 105..... 7
KC 145-1522D.....10
KC 1515..... 7
KC 18901-K..... 9
KC 18901-L..... 9
KC 18901-O..... 9
KC 18901-P..... 9
KC 211-D.....11
KC 2119..... 8
KC 212-D.....11
KC 2124..... 7
KC 2126..... 8
KC 213-D.....11
KC 5..... 9
KC 6PA..... 9
KC 9-P.....15
KC Series.....18
KC-N Series.....18
KC-P Series.....18
KC-3 Series.....18

KC-5 Series..... 19
KC-5N Series..... 19
KC-5P Series..... 19
KM 030.....12

M

MS 101-40..... 9

N

NB 105-6..... 8
NL 100.....36
NP 1000-2D.....30
NP 105-1.....17
NP 130-22..... 9
 NS 120-TRR.....21
 NS 120-TRS.....20
 NS 120P-TRS.....20
NS 30-115-5.....14
NS 30-115-5L.....14
NS 30-115-U.....14
NS 30-115-UL.....14
 NS 30-PBR.....21
 NS 30-PBS.....20
 NS 30-TRR.....21
 NS 30-TRS.....20
 NS 60-PBR.....21
 NS 60-PBS.....20
 NS 60-TBR.....21
 NS 60-TBS.....20
 NS 60-TBS-CP.....27
 NS 60-TRR.....21
 NS 60-TRS.....20
 NS 60-TRS-CP.....27
NS-GC.....22
NS-GS.....22
 NS-RC.....21
 NS-SC.....20

P

PF 001.....10
PF 1010.....10
PF 1510.....10
PF 1515.....10
PS 54-1A.....14
PS 54A.....14
PS 54AL.....14

R

RB 001.....17
RB 002.....16
RB 004.....22
RB KNOB.....16
RTC 15-D..... 4
RTC 15-P..... 4

RTC 17-1.....4,12
RTC 21-A..... 4
RTC 21-D..... 4
RTC 22-A..... 4
RTC 22-D..... 4
RTC 23-A..... 4
RTC 23-D..... 4
RTC 24-V..... 5
RTC 24-V KIT..... 5
RTC 24-VP..... 5
RTC 26-C..... 6

S

SC 603-A.....31
SG 066.....19
SG 066-1.....19
SG 066-2N.....19,29
SG 066-2N-2P.....29
SG 101..... 8
SG 101-D..... 8
SG 1010..... 7
SG 102..... 8
SG 193-M..... 8
SG 218..... 7
 SH 7-2.....33
 SH 7-45.....12
 SH 7-47.....36
 SH 74-BK.....32
 SH 74-BL.....32
SH 74-C.....32
SH 74-G.....32
SH 74-W.....32
SH74-Y.....32
 SH 75 Series.....32
 SH 77 Series.....24
 SM-501.....25
 SM-502.....25
 SM-503.....25
 SM-504.....25
 SM-505.....25
 SM-MH.....25
 SM-PH.....25

W

WT 125.....15
WT 125-BI.....15
WT 125-BOT.....15
WT 250.....15
WT 250-BI.....15
WT 250-BOT.....15

*Providing quality medical
products
since*

1967

*"We breathe easy when the
world breathes easier!"*



Instrumentation

Industries, Inc.
Since 1967

2990 Industrial Blvd. • Bethel Park, PA 15102

US Toll Free: 1-800-633-8577

Business: 1-412-854-1133

US Toll Free Fax: 1-877-633-8661

Fax: 1-412-854-5668

E-mail: sales@iiimedical.com

iiimedical.com



MMSI



McARTHUR
MEDICAL SALES INC.

1846 5th Concession W.,
P.O. Box 7, Rockton, ON LOR 1X0

Tel.: 519-622-4030

Toll: 1-800-996-6674

Fax: 519-622-1142

mmsi@mcarthurmedical.com

www.mcarthurmedical.com